

2019-20 BOE Organization Chart

Contents

2019-20 BOE Org Chart	1
Contents.....	2
EXECUTIVE DIVISION.....	4
PUBLIC BUILDINGS & OPEN SPACES PROGRAM.....	5
ARCHITECTURAL DIVISION (1 OF 3).....	6
ARCHITECTURAL DIVISION (2 OF 3).....	7
ARCHITECTURAL DIVISION (3 OF 3).....	8
BRIDGE IMPROVEMENT DIVISION.....	9
CONSTRUCTION MANAGEMENT DIVISION.....	10
HOMELESS FACILITIES AND SPECIAL PROJECT DIVISION.....	11
L.A. RIVER PROJECT OFFICE.....	12
CIVIC CENTER DEVELOPMENT PROGRAM.....	13
CLEAN WATER INFRASTRUCTURE PROGRAM.....	14
ENVIRONMENTAL ENGINEERING DIVISION (PAGE 1 OF 3).....	15
ENVIRONMENTAL ENGINEERING DIVISION (PAGE 2 OF 3).....	16
ENVIRONMENTAL ENGINEERING DIVISION (PAGE 3 OF 3).....	17
PROJECT AWARD & CONTROL DIVISION.....	18
PROP O BOND PROGRAM.....	19
SURVEY DIVISION (PAGE 1 OF 2).....	20
SURVEY DIVISION (PAGE 2 OF 2).....	21
WASTEWATER CONVEYANCE CONSTRUCTION DIVISION.....	22
WASTEWATER CONVEYANCE ENGINEERING DIVISION (PAGE 1 OF 2)....	23
WASTEWATER CONVEYANCE ENGINEERING DIVISION (PAGE 2 OF 2)	24
DEVELOPMENT SERVICES & PERMITS PROGRAM.....	25

Contents Continued

CENTRAL DISTRICT.....	26
HARBOR DISTRICT.....	27
LAND DEVELOPMENT & GIS DIVISION (1 OF 2).....	28
LAND DEVELOPMENT & GIS DIVISION (2 OF 2).....	29
LAMP.....	30
PERMIT CASE MANAGEMENT DIVISION.....	31
SYSTEMS DIVISION.....	32
VALLEY DISTRICT (PAGE 1 OF 2).....	33
VALLEY DISTRICT (PAGE 2 OF 2).....	34
WEST LA DISTRICT.....	35
MOBILITY & ENGINEERING SERVICES PROGRAM.....	36
ENVIRONMENTAL MANAGEMENT GROUP.....	37
GEOTECHNICAL ENGINEERING DIVISION.....	38
METRO TRANSIT DIVISION.....	39
REAL ESTATE DIVISION.....	40
SIXTH STREET VIADUCT DIVISION.....	41
STREET IMPROVEMENT AND STORMWATER DIVISION (PAGE 1 OF 2).....	42
STREET IMPROVEMENT AND STORMWATER DIVISION (PAGE 2 OF 2).....	43
STRUCTURAL ENGINEERING DIVISION.....	44
SIDEWALK AND COMPLETE STREETS PROGRAM.....	45
COMPLETE STREETS DIVISION.....	46
SIDEWALK REPAIR DIVISION.....	47
ADMINISTRATION DIVISION.....	48

BUREAU OF ENGINEERING EXECUTIVE DIVISION 2019-20 ORGANIZATION CHART

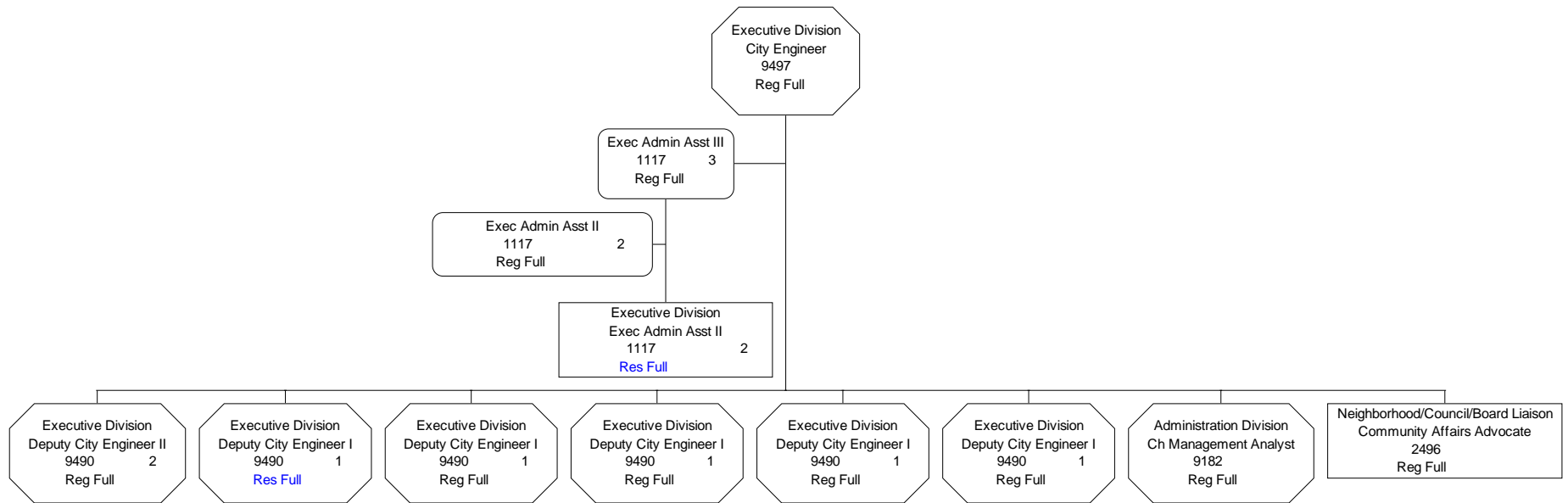

**BUREAU OF ENGINEERING
PUBLIC BUILDINGS & OPEN SPACES PROGRAM
2019-20 ORGANIZATION CHART**

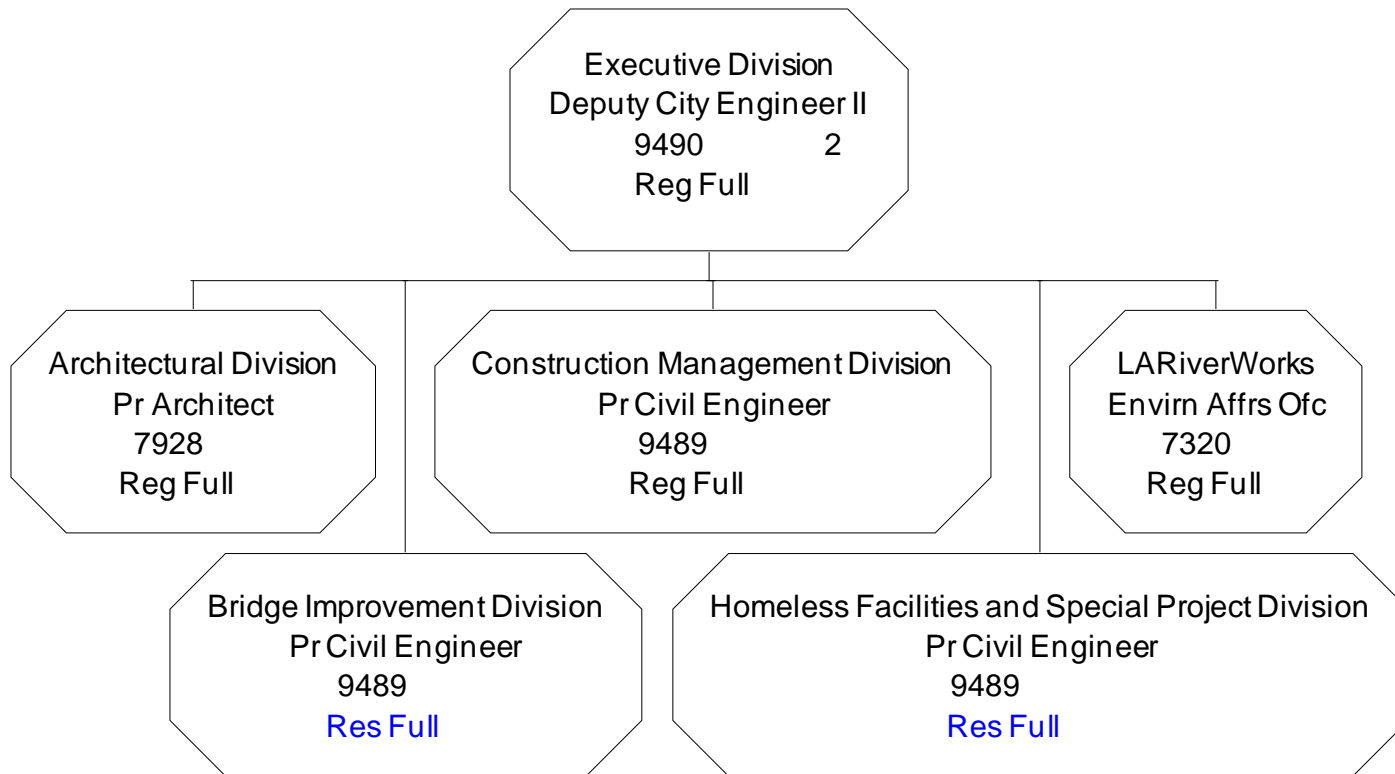

**BUREAU OF ENGINEERING
ARCHITECTURAL DIVISION (1 OF 3)
2019-20 ORGANIZATION CHART**

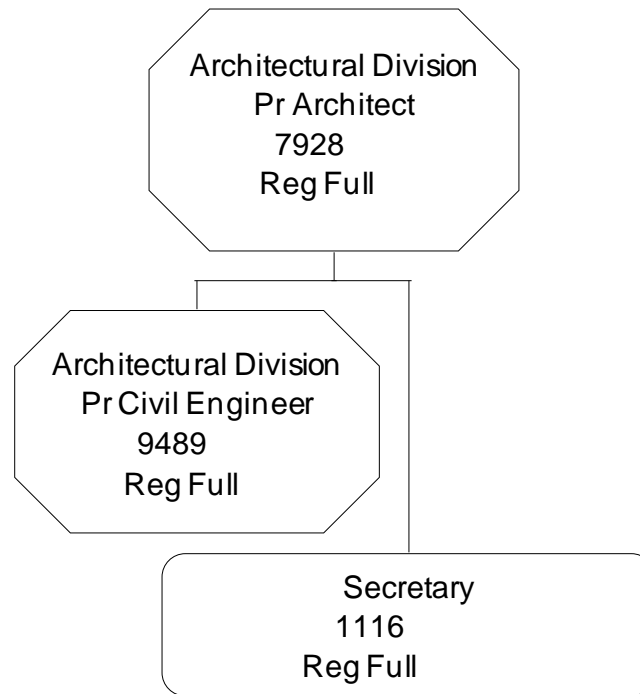

BUREAU OF ENGINEERING ARCHITECTURAL DIVISION (3 OF 3) 2019-20 ORGANIZATION CHART

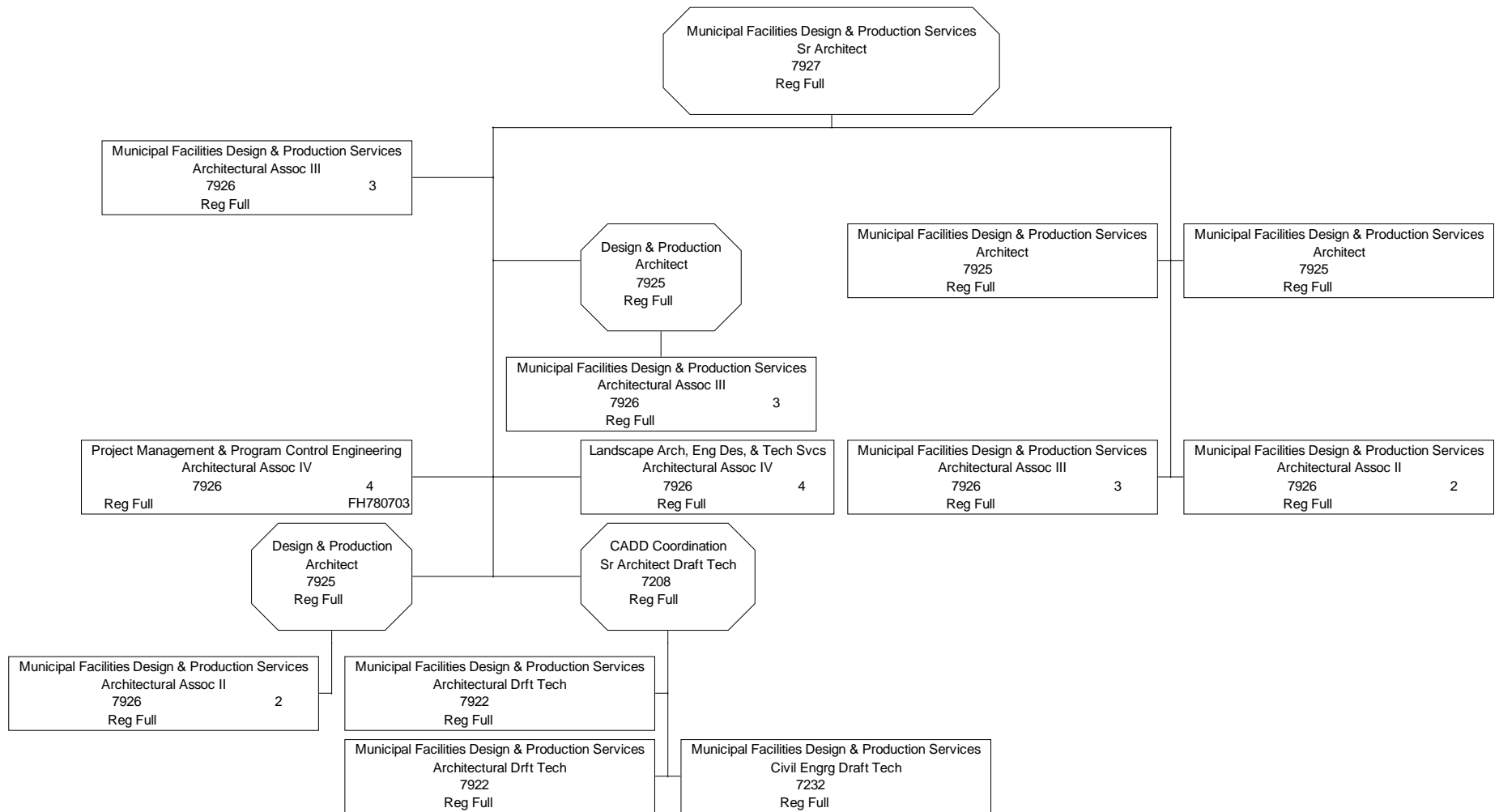

BUREAU OF ENGINEERING BRIDGE IMPROVEMENT DIVISION 2019-20 ORGANIZATION CHART

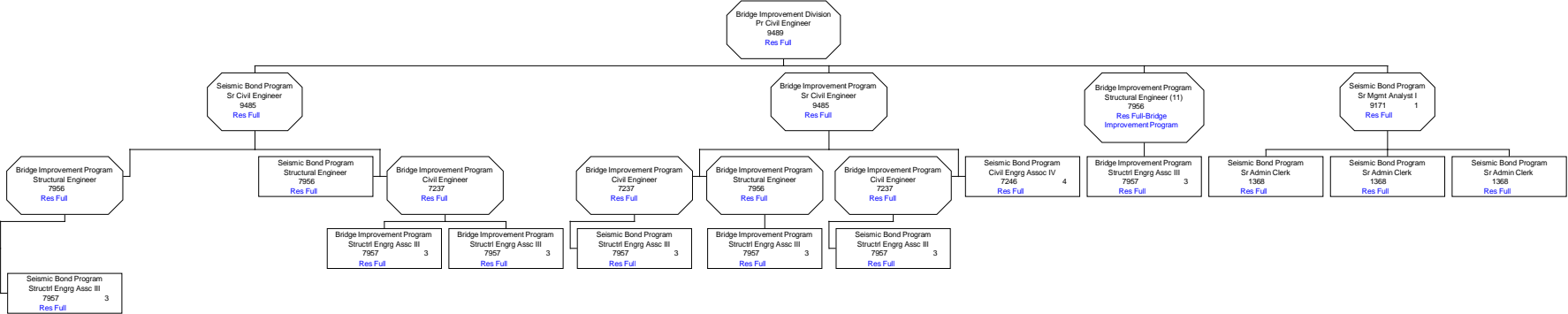

BUREAU OF ENGINEERING CONSTRUCTION MANAGEMENT DIVISION 2019-20 ORGANIZATION CHART

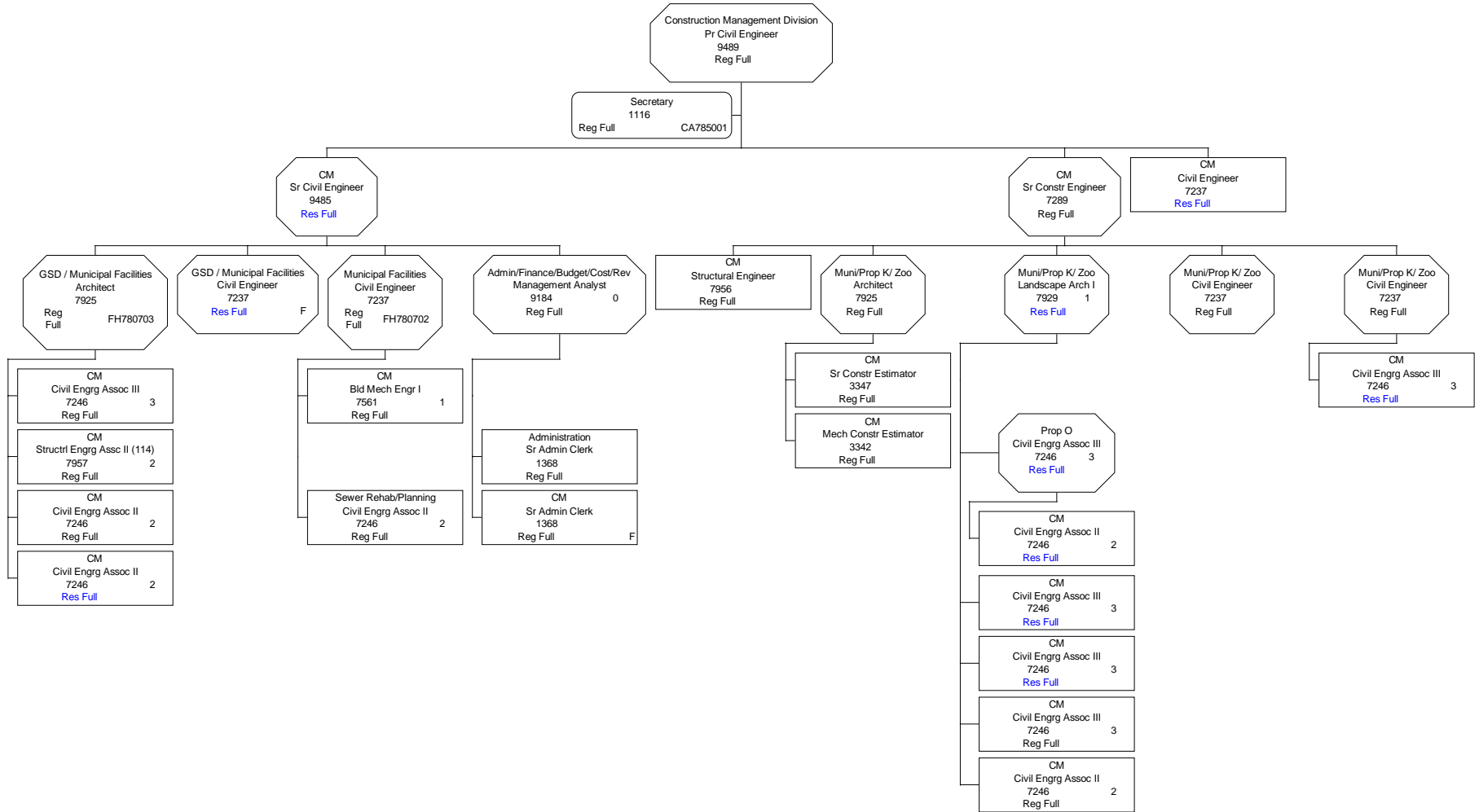

BUREAU OF ENGINEERING HOMELESS FACILITIES AND SPECIAL PROJECT DIVISION 2019-20 ORGANIZATION CHART

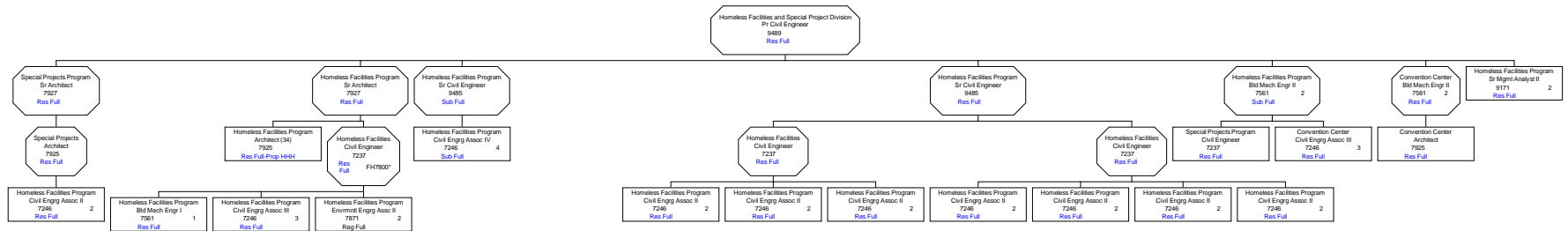

**BUREAU OF ENGINEERING
L.A. RIVER PROJECT OFFICE
2019-20 ORGANIZATION CHART**

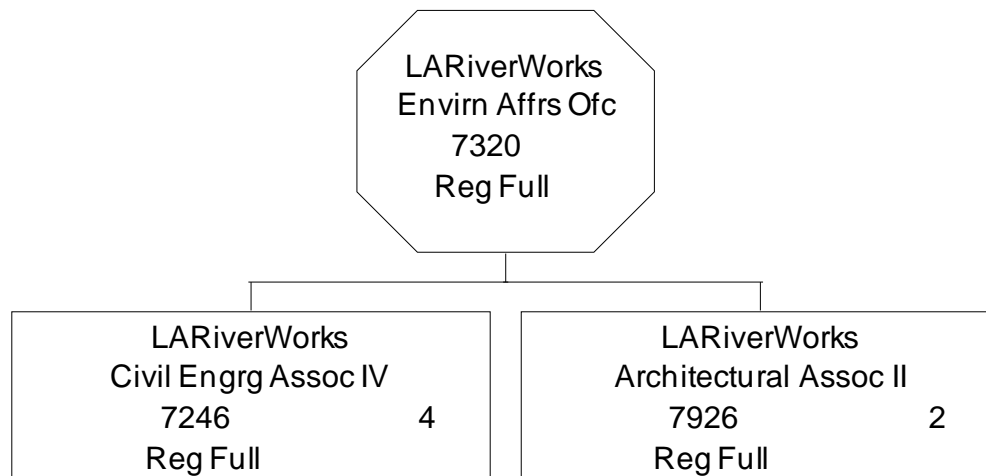

**BUREAU OF ENGINEERING
CIVIC CENTER DEVELOPMENT PROGRAM
2019-20 ORGANIZATION CHART**

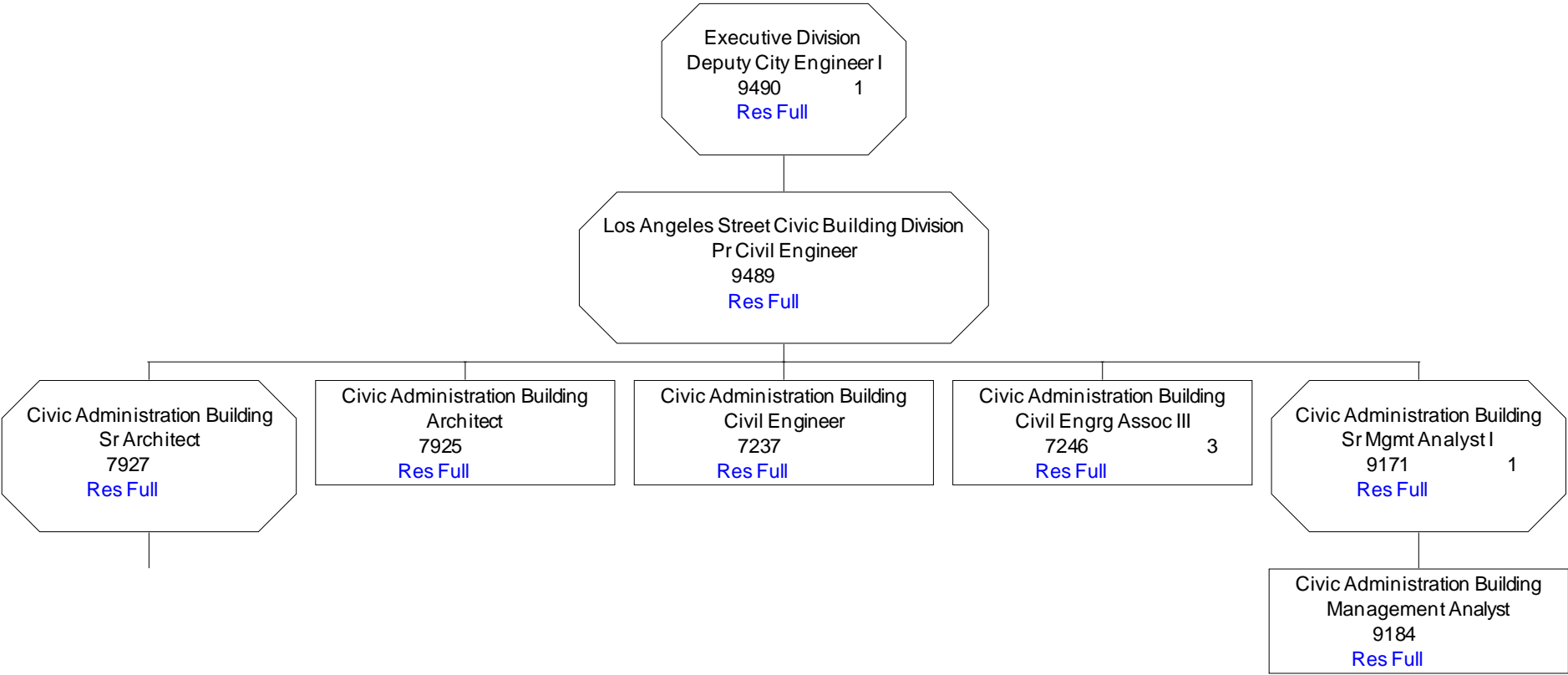

BUREAU OF ENGINEERING CLEAN WATER INFRASTRUCTURE PROGRAM 2019-20 ORGANIZATION CHART

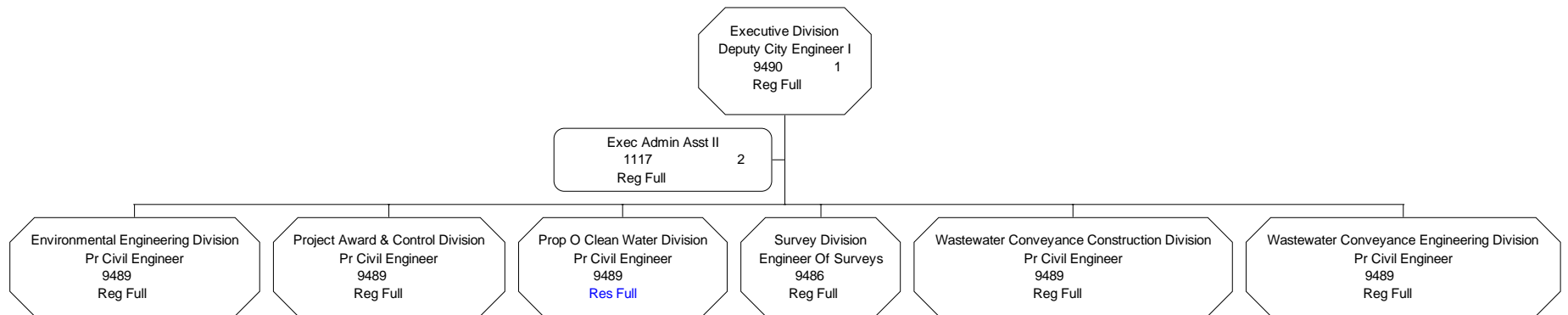

BUREAU OF ENGINEERING ENVIRONMENTAL ENGINEERING DIVISION (PAGE 1 OF 3) 2019-20 ORGANIZATION CHART

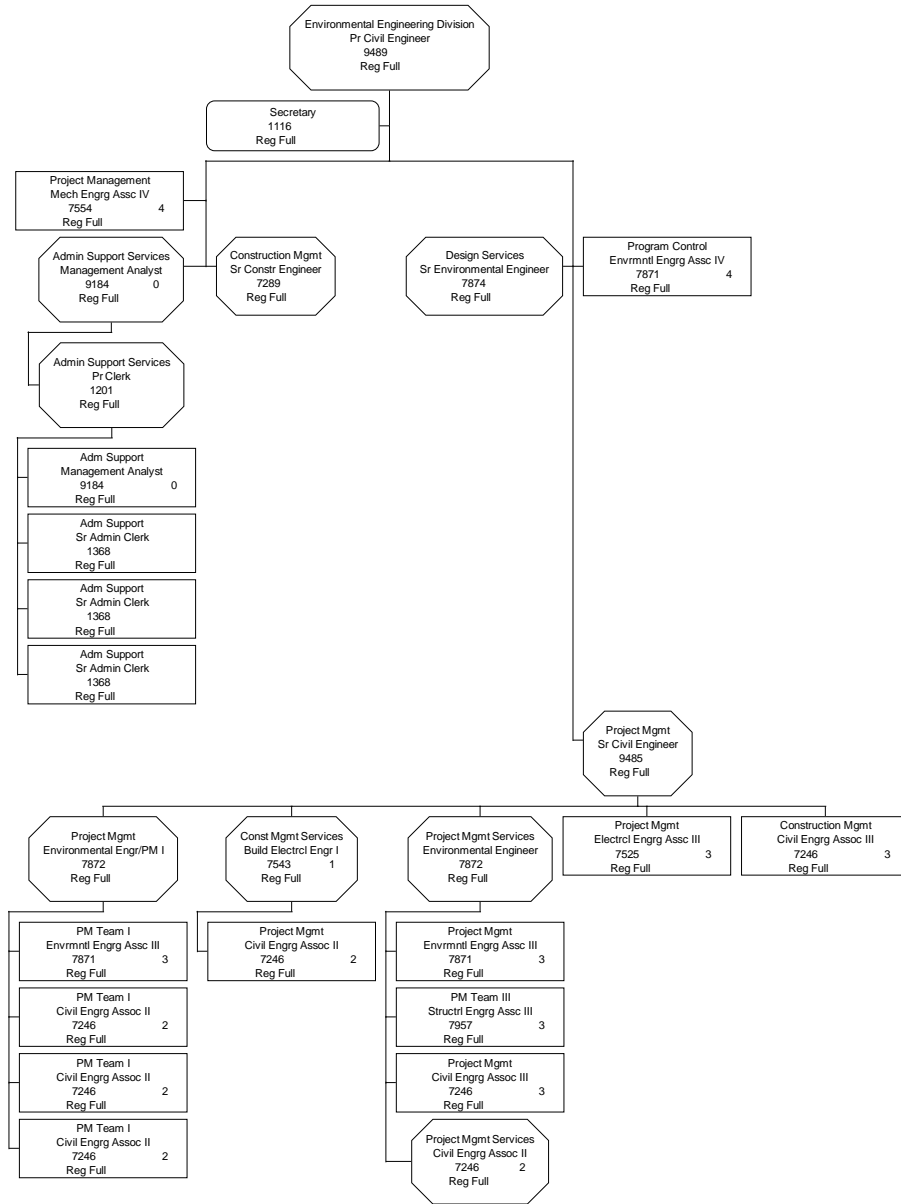

BUREAU OF ENGINEERING ENVIRONMENTAL ENGINEERING DIVISION (PAGE 2 OF 3) 2019-20 Construction Mgmt Sr Constr Engineer 7289 Reg Full

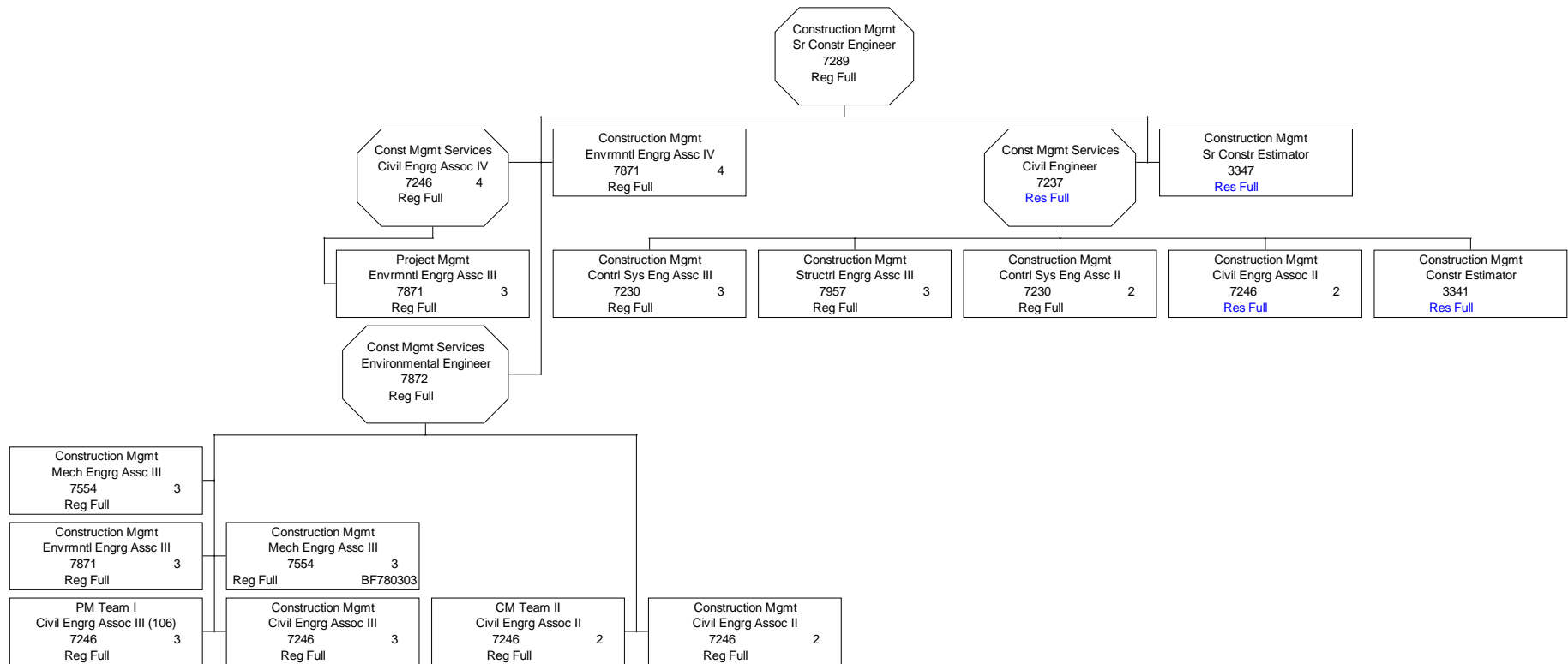

BUREAU OF ENGINEERING

ENVIRONMENTAL ENGINEERING DIVISION (PAGE 3 OF 3)

2019-2020 ORGANIZATION CHART

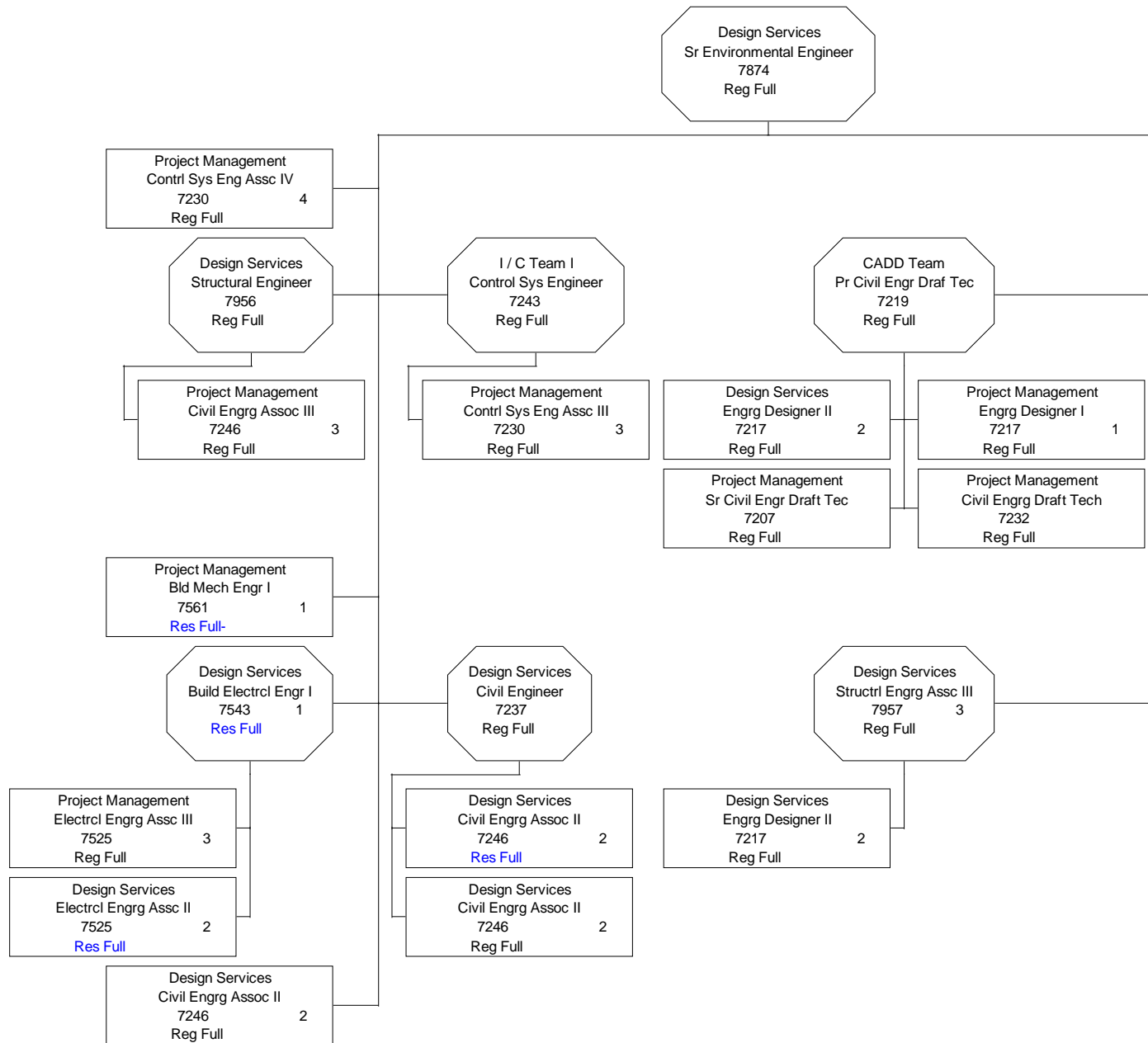

BUREAU OF ENGINEERING PROJECT AWARD & CONTROL DIVISION 2019-20 ORGANIZATION CHART

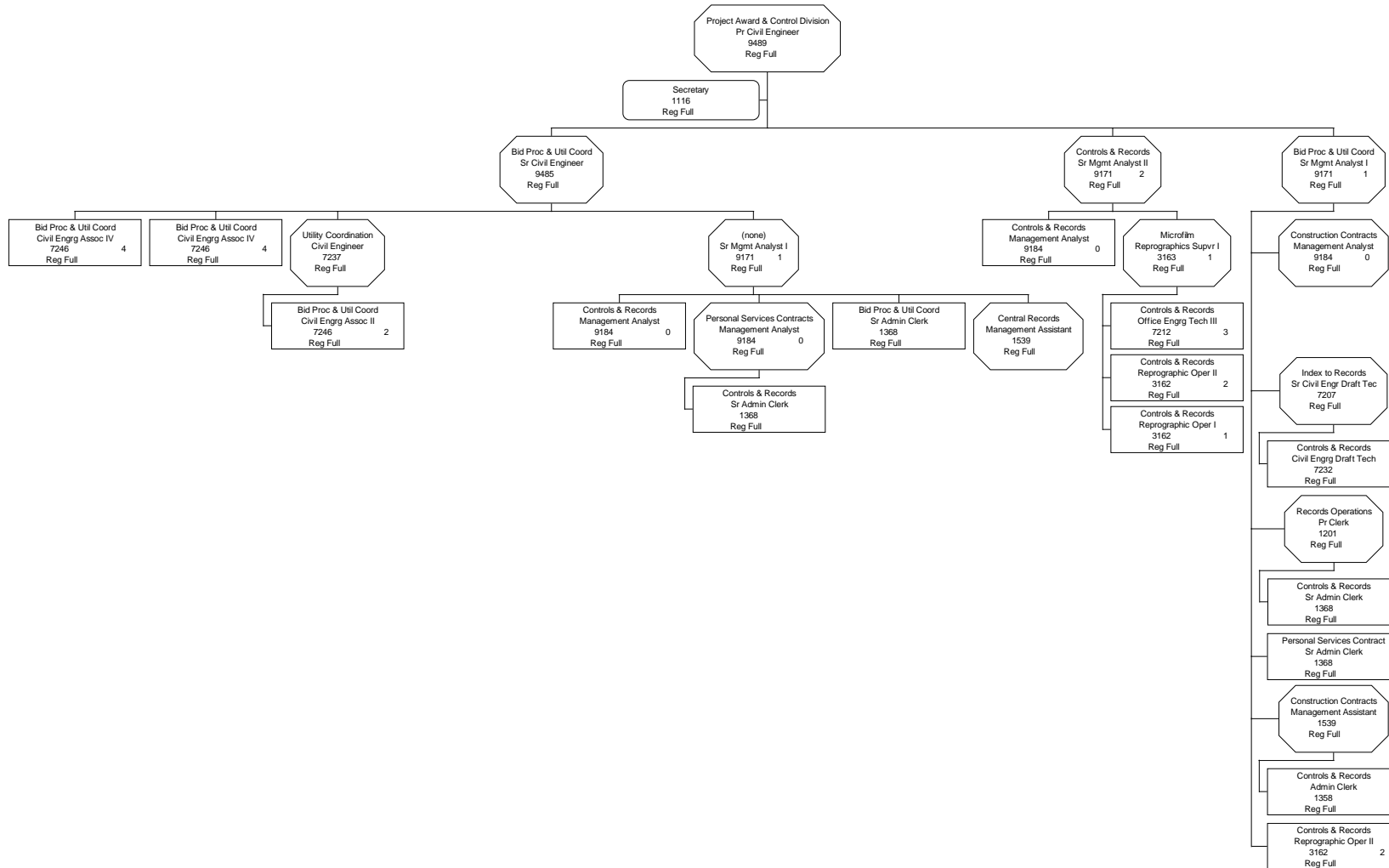

BUREAU OF ENGINEERING PROP O BOND PROGRAM 2019-20 ORGANIZATION CHART

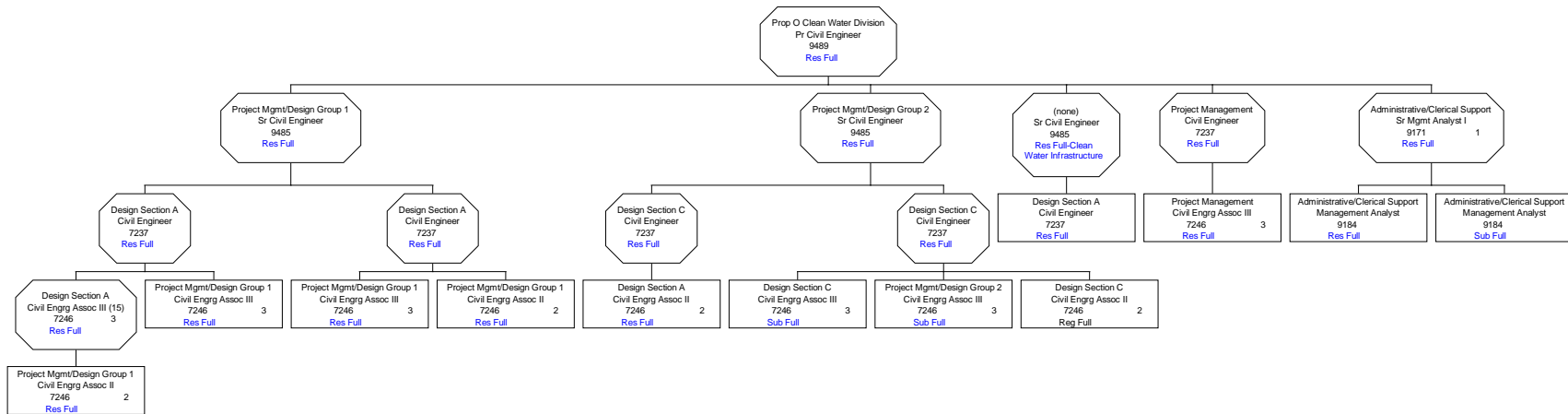

BUREAU OF ENGINEERING

WASTEWATER CONVEYANCE ENGINEERING DIVISION (PAGE 1 OF 2)

2019-20 Division Organization Chart

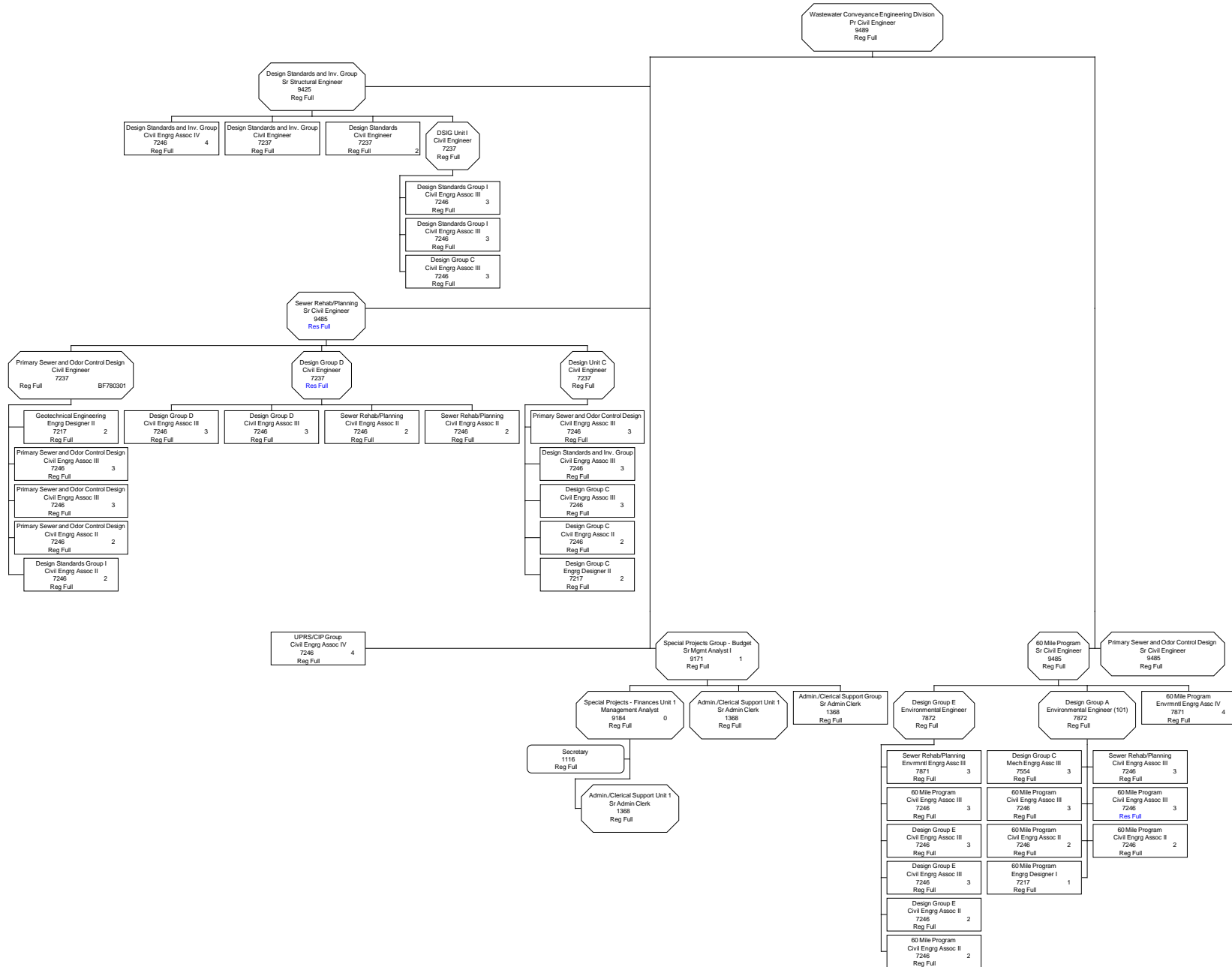

**BUREAU OF ENGINEERING
WASTEWATER CONVEYANCE ENGINEERING DIVISION (PAGE 2 OF 2)
2019-20 ORGANIZATION CHART**

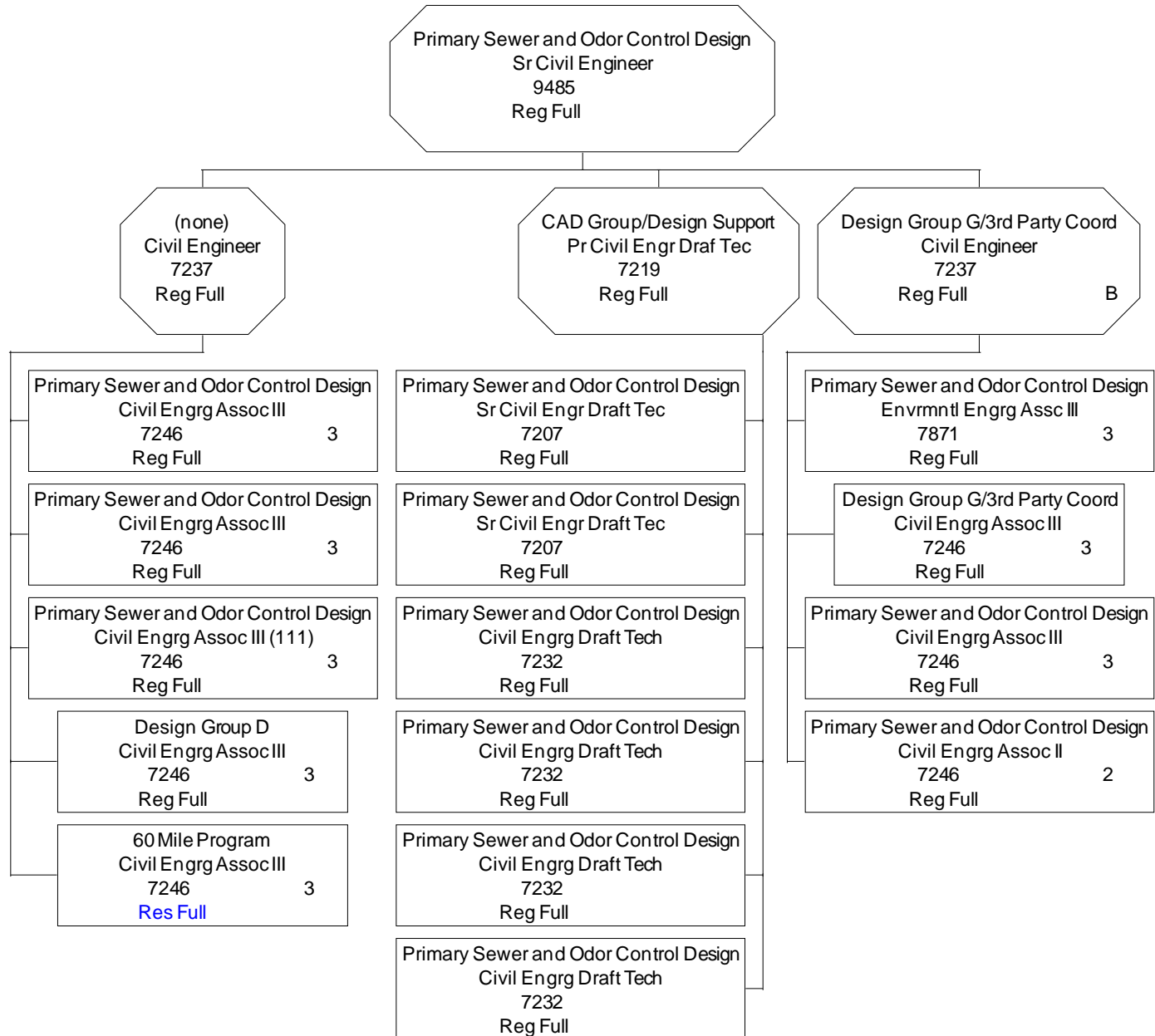

**BUREAU OF ENGINEERING
DEVELOPMENT SERVICES & PERMITS PROGRAM
2019-20 ORGANIZATION CHART**

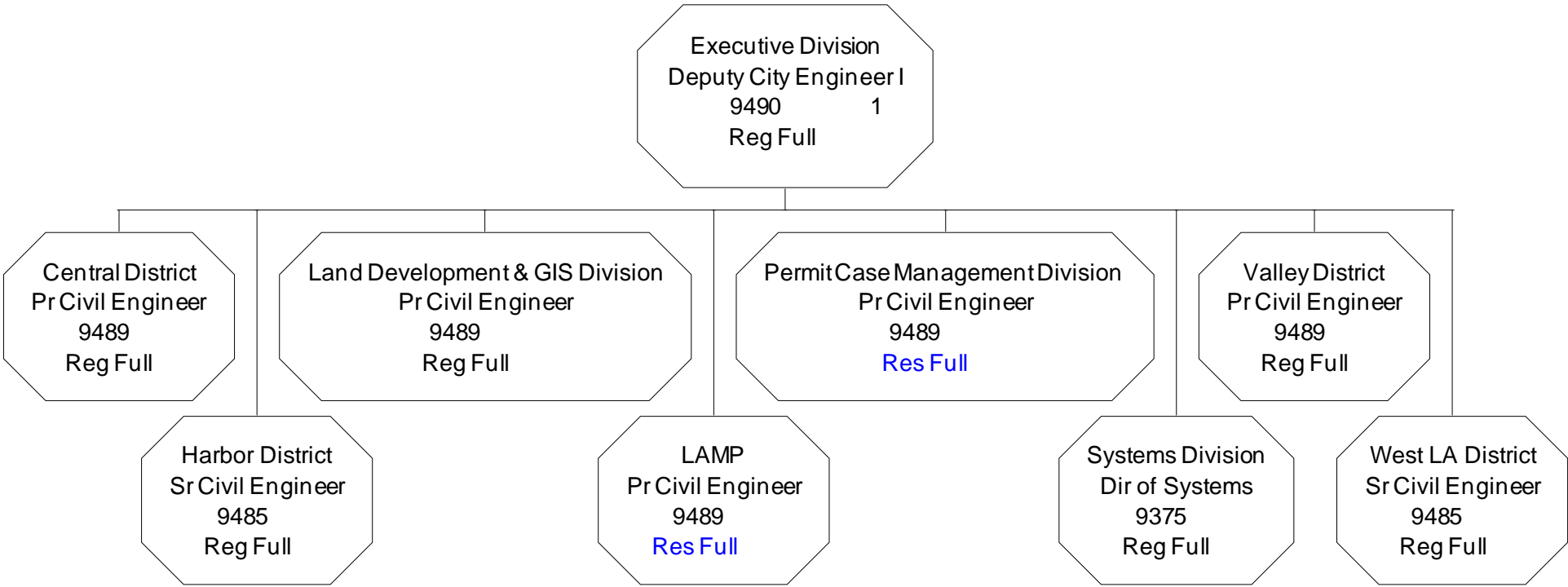

BUREAU OF ENGINEERING HARBOR DISTRICT 2019-20 ORGANIZATION CHART

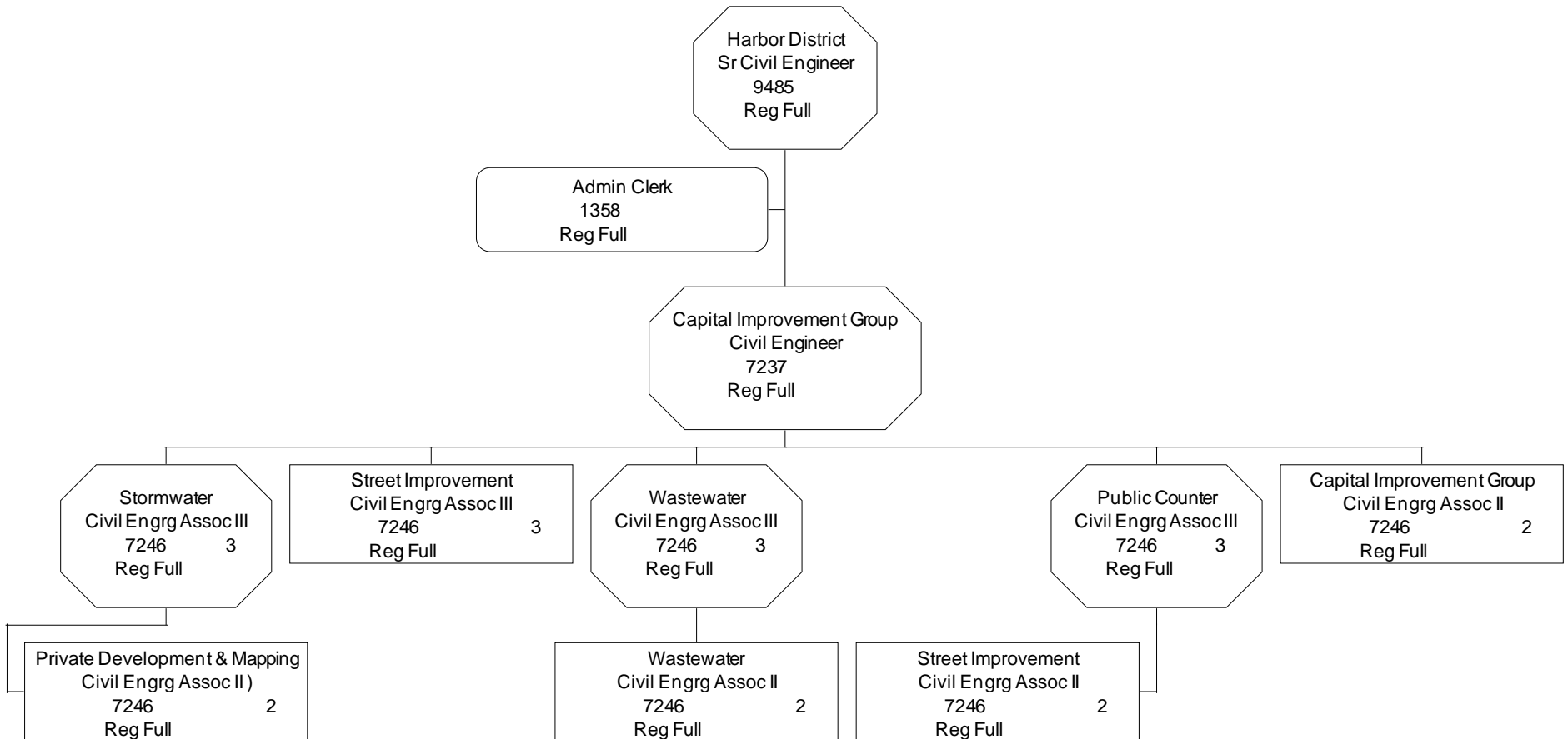

BUREAU OF ENGINEERING LAND DEVELOPMENT & GIS DIVISION (2 OF 2) 2019-2020 ORGANIZATION CHART

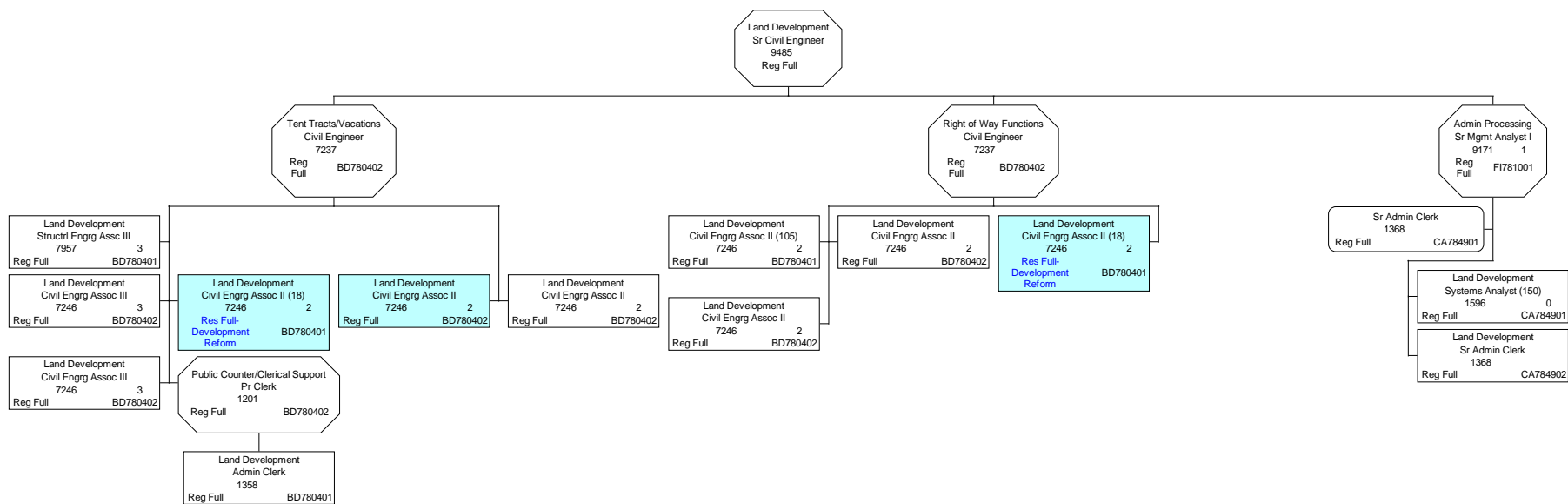

**BUREAU OF ENGINEERING
LAMP
2019-20 ORGANIZATION CHART**

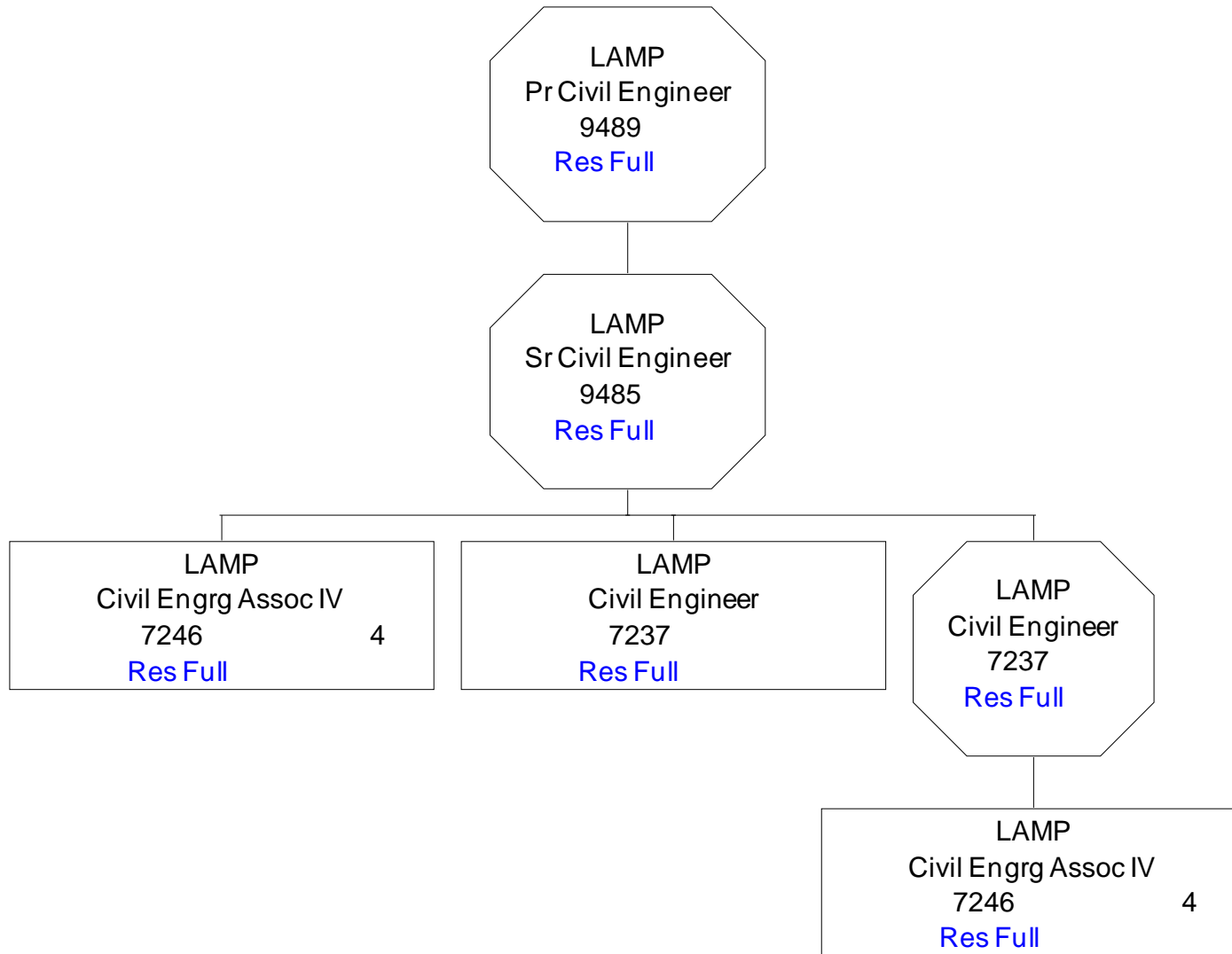

**BUREAU OF ENGINEERING
PERMIT CASE MANAGEMENT DIVISION
2019-20 ORGANIZATION CHART**

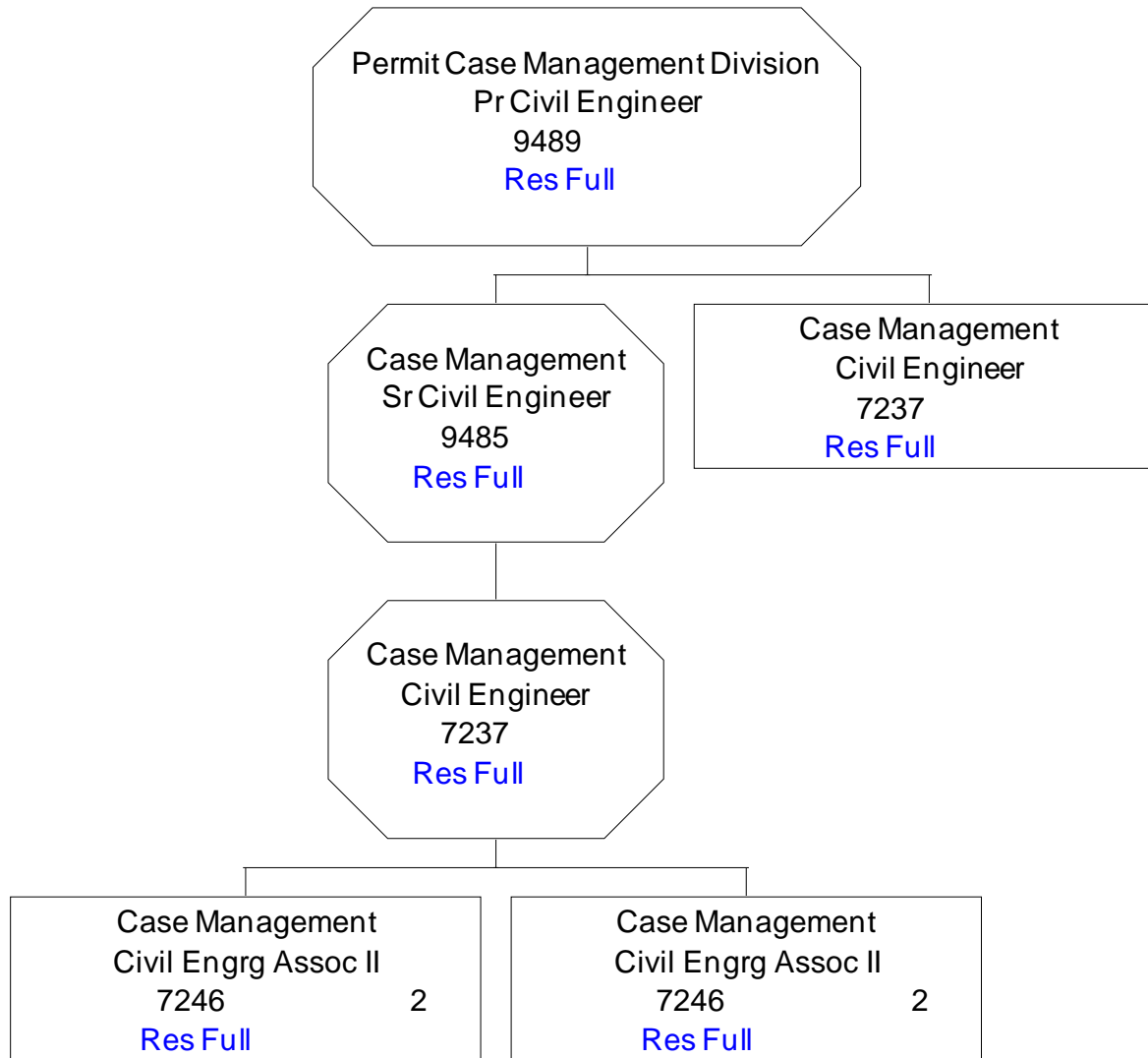

BUREAU OF ENGINEERING SYSTEMS DIVISION 2019-20 ORGANIZATION CHART

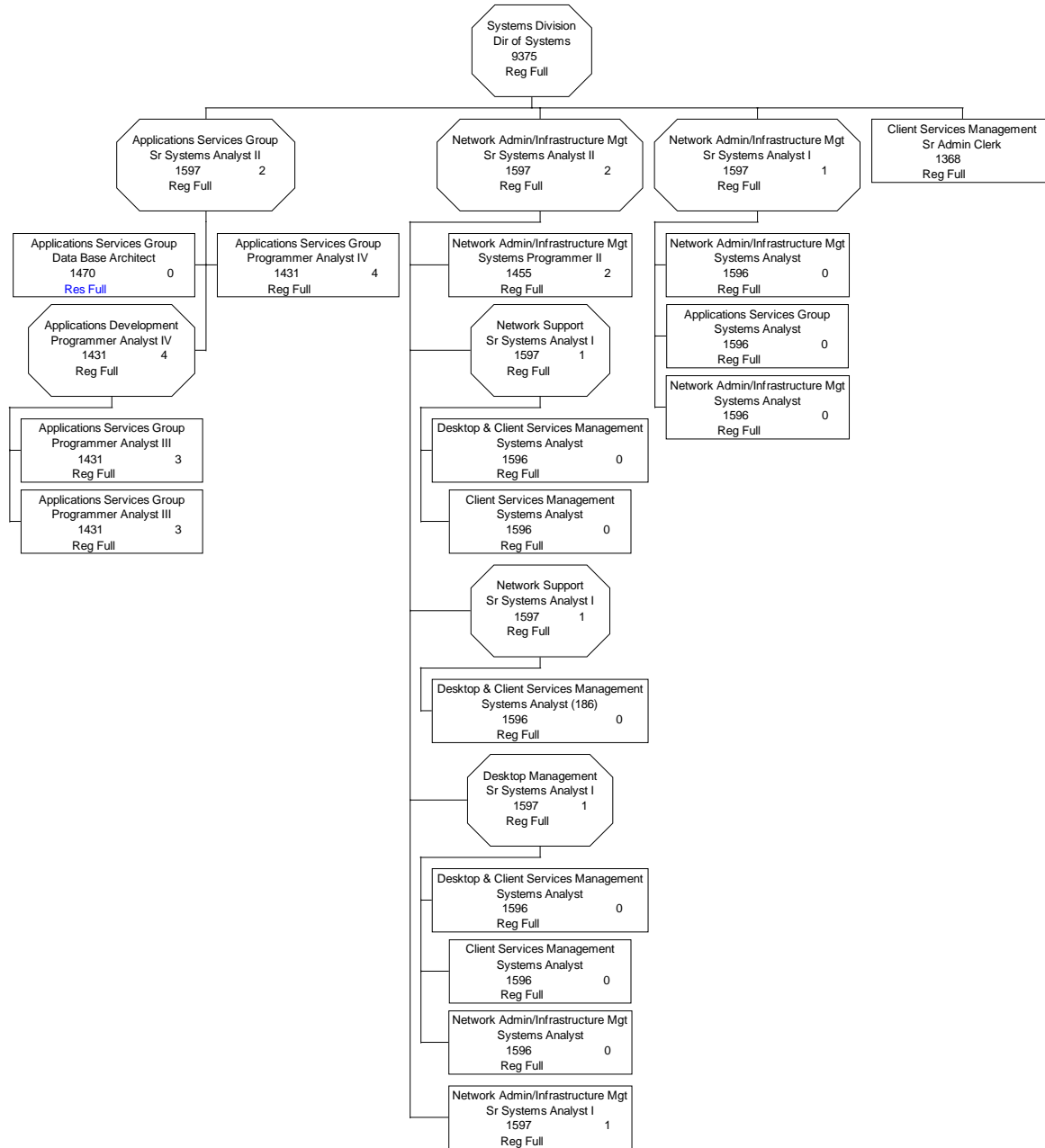

BUREAU OF ENGINEERING VALLEY DISTRICT (PAGE 1 OF 2) 2019-20 ORGANIZATION CHART

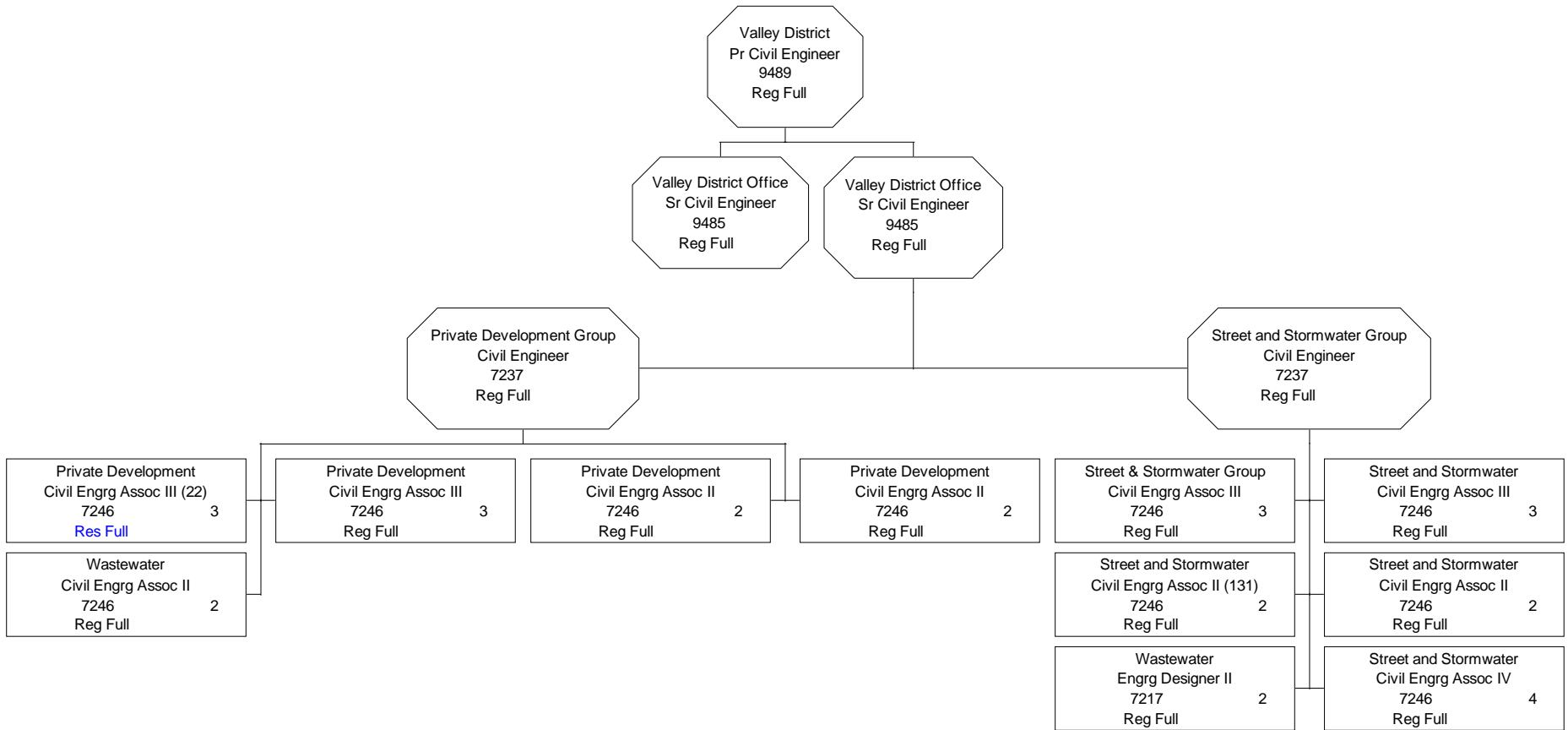

BUREAU OF ENGINEERING VALLEY DISTRICT (PAGE 2 OF 2) 2019-20 ORGANIZATION CHART

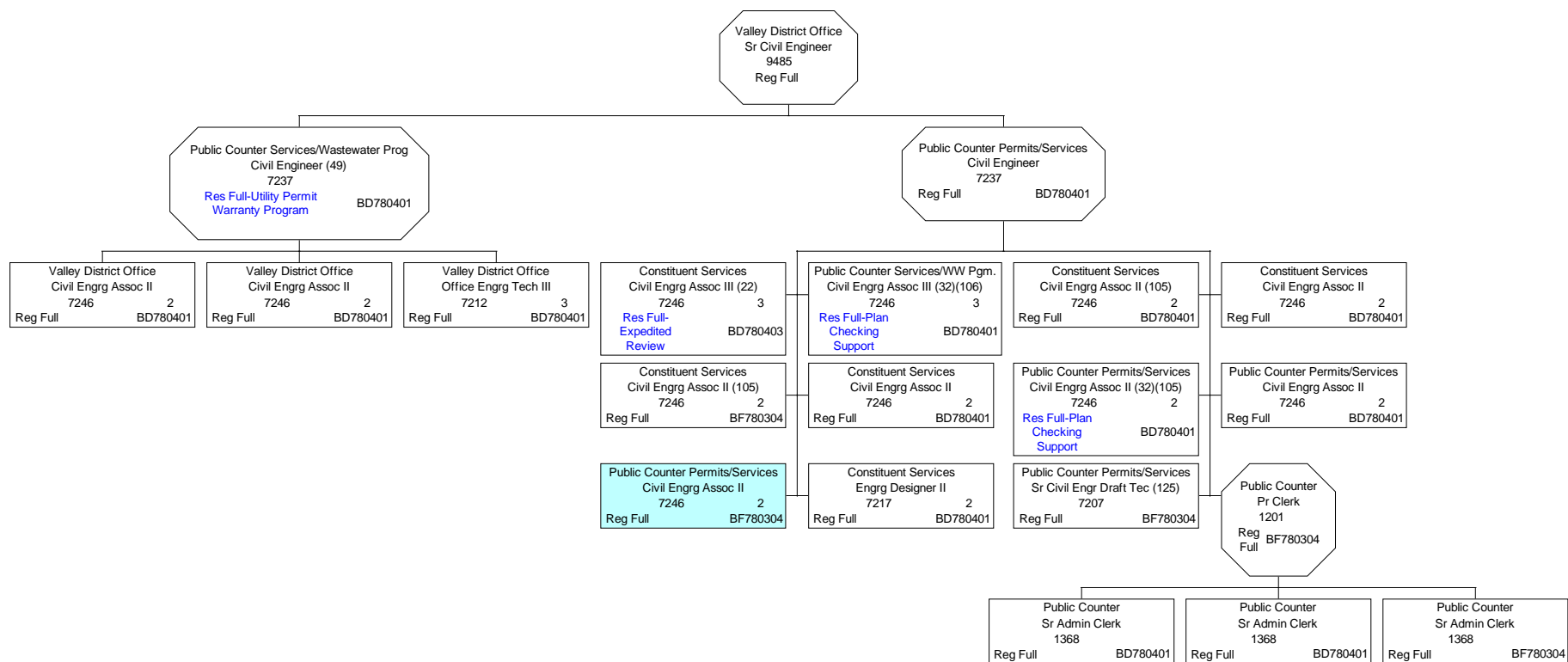

BUREAU OF ENGINEERING WEST LA DISTRICT 2019-20 ORGANIZATION CHART

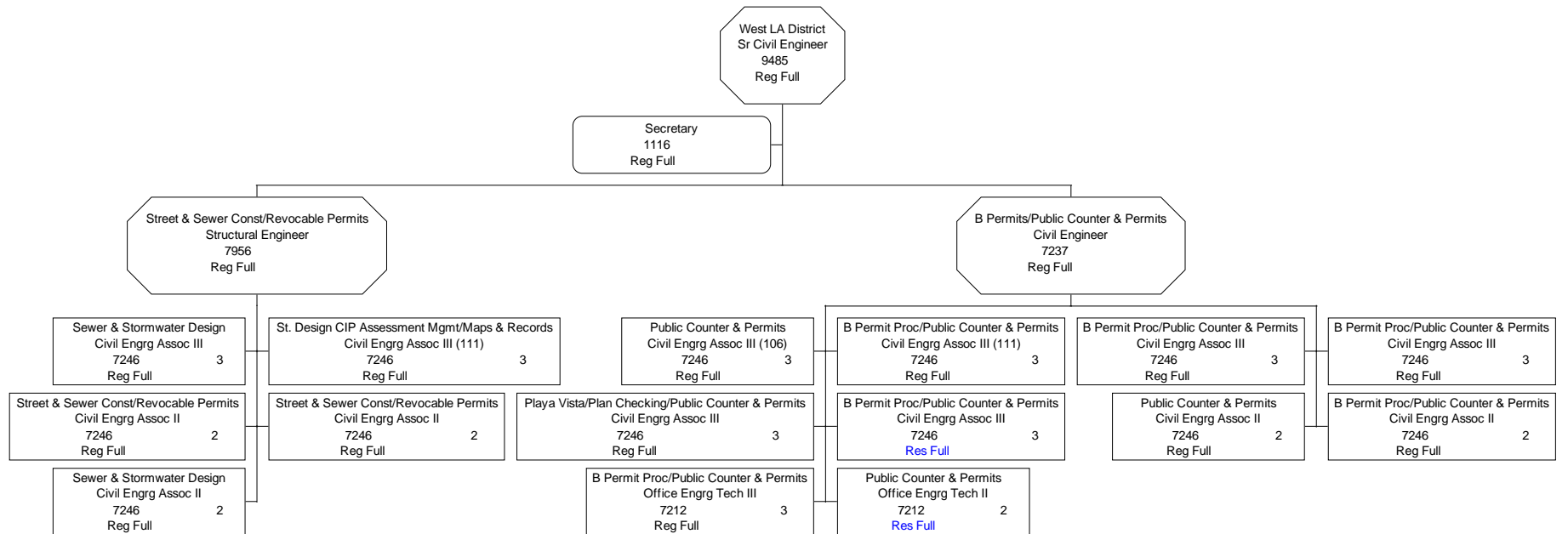

**BUREAU OF ENGINEERING
MOBILITY & ENGINEERING SERVICES PROGRAM
2019-20 ORGANIZATION CHART**

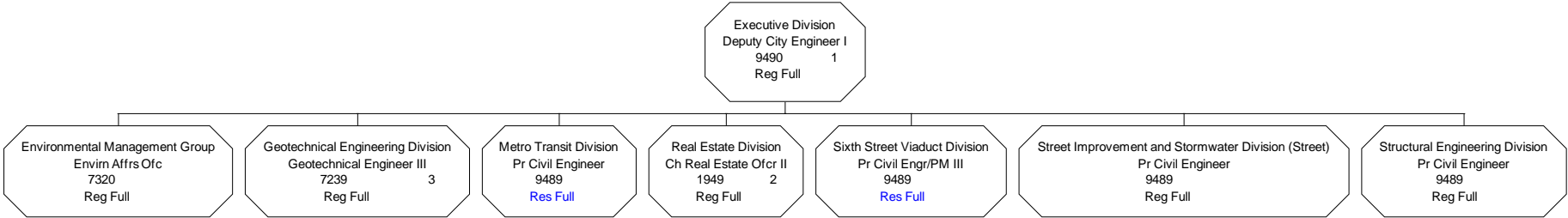

BUREAU OF ENGINEERING ENVIRONMENTAL MANAGEMENT GROUP 2019-20 ORGANIZATION CHART

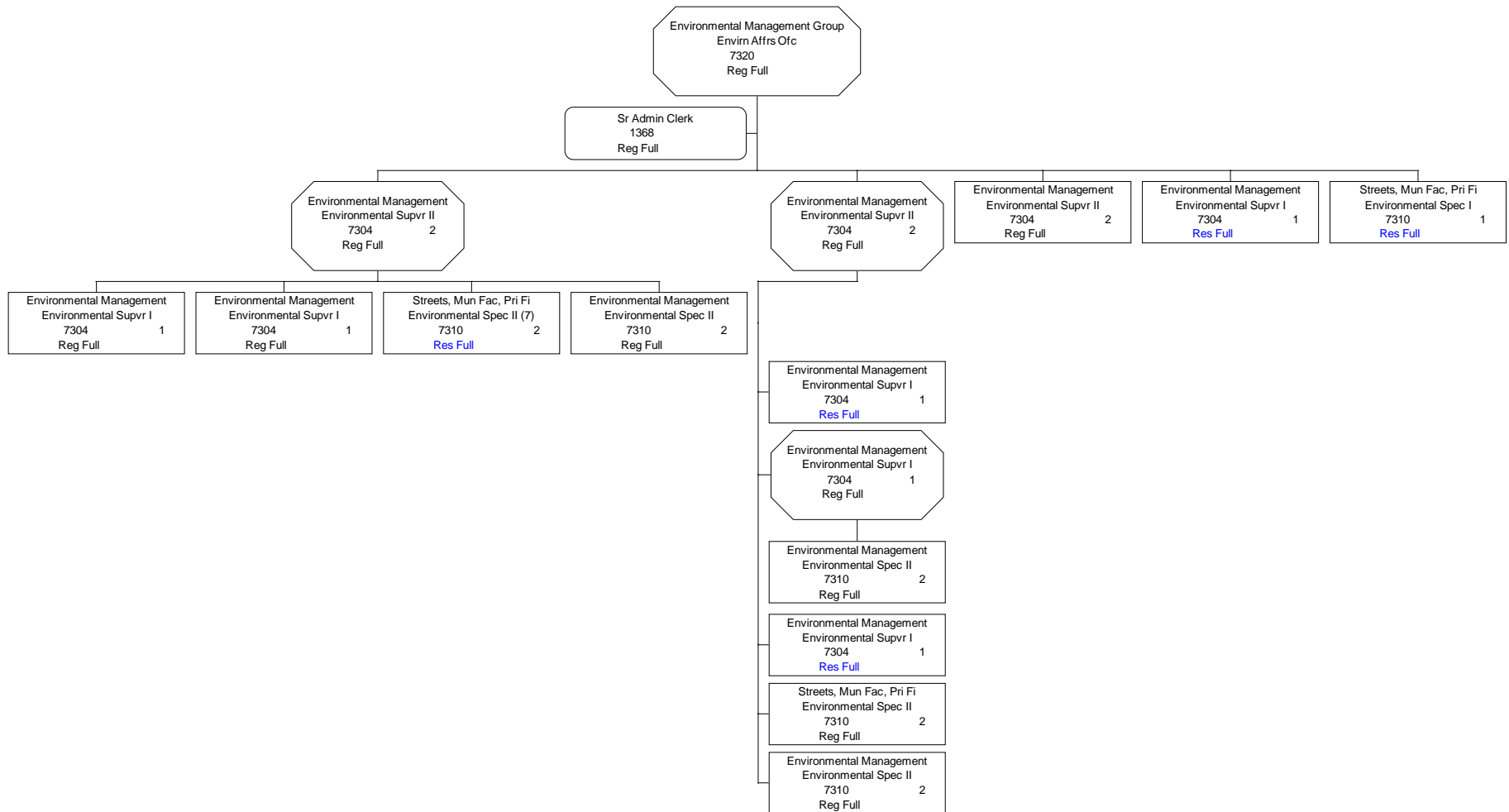

BUREAU OF ENGINEERING GEOTECHNICAL ENGINEERING DIVISION 2019-20 ORGANIZATION CHART

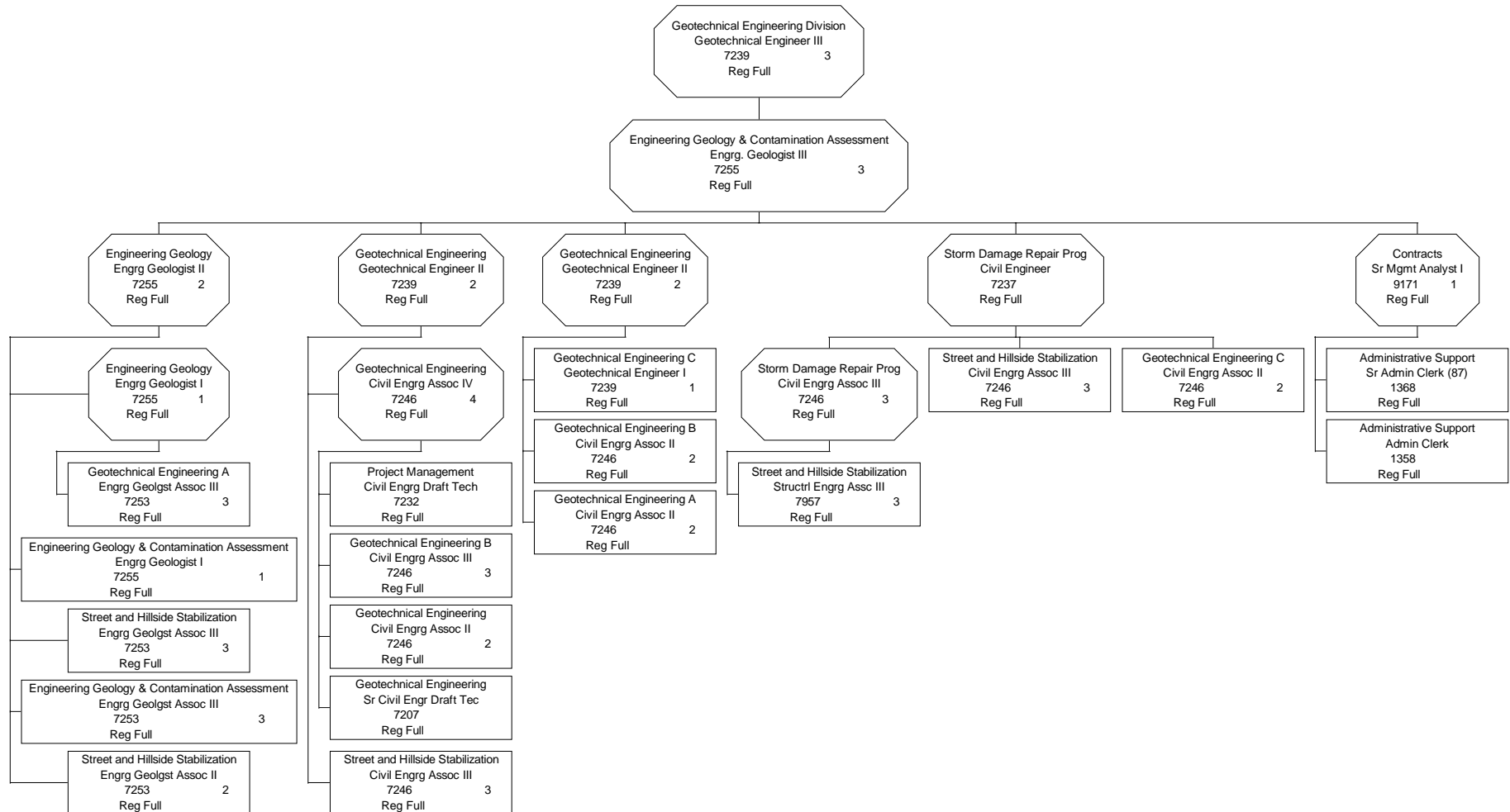

BUREAU OF ENGINEERING METRO TRANSIT DIVISION 2019-20 ORGANIZATION CHART

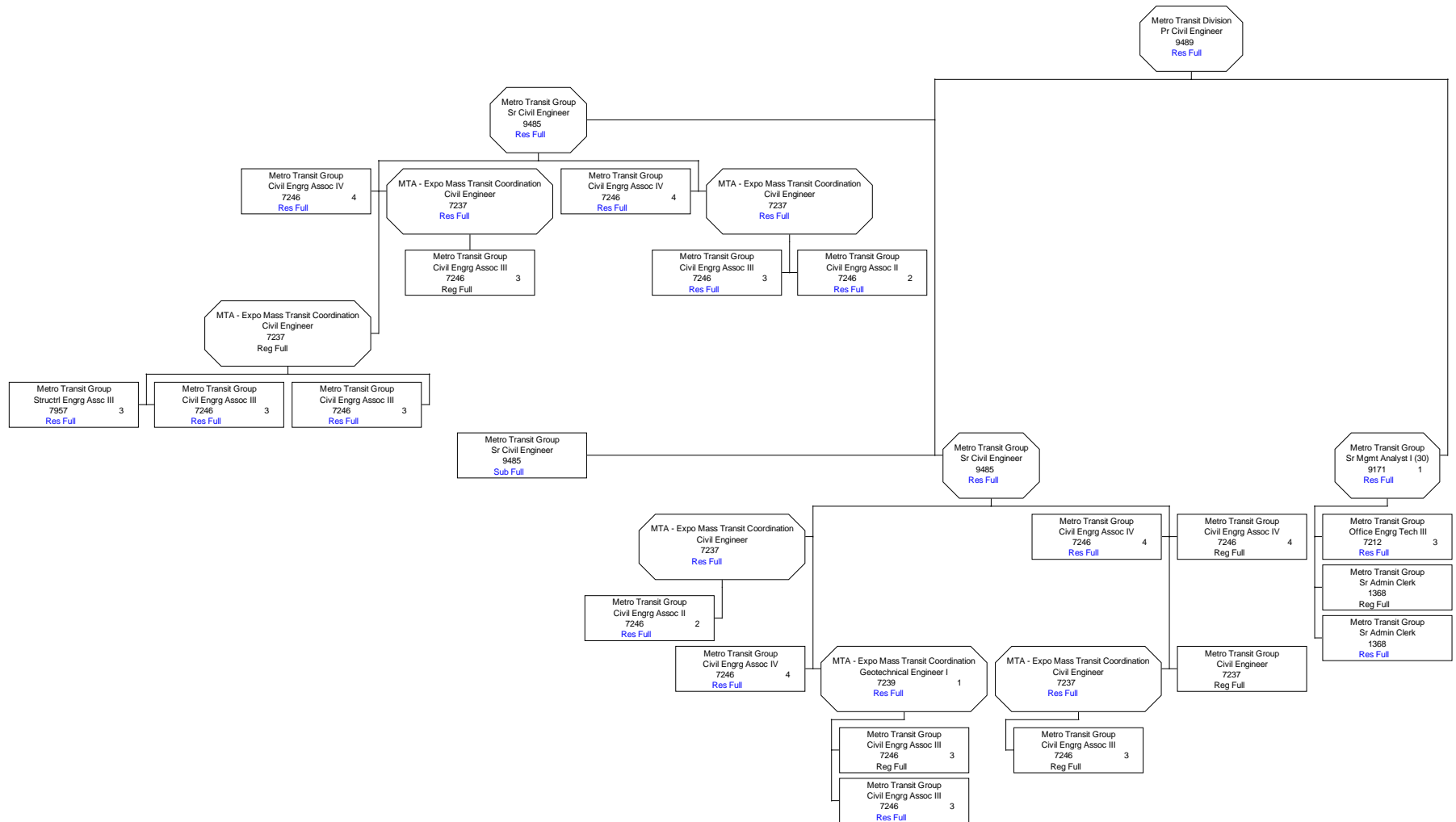

**BUREAU OF ENGINEERING
REAL ESTATE DIVISION
2019-20 ORGANIZATION CHART**

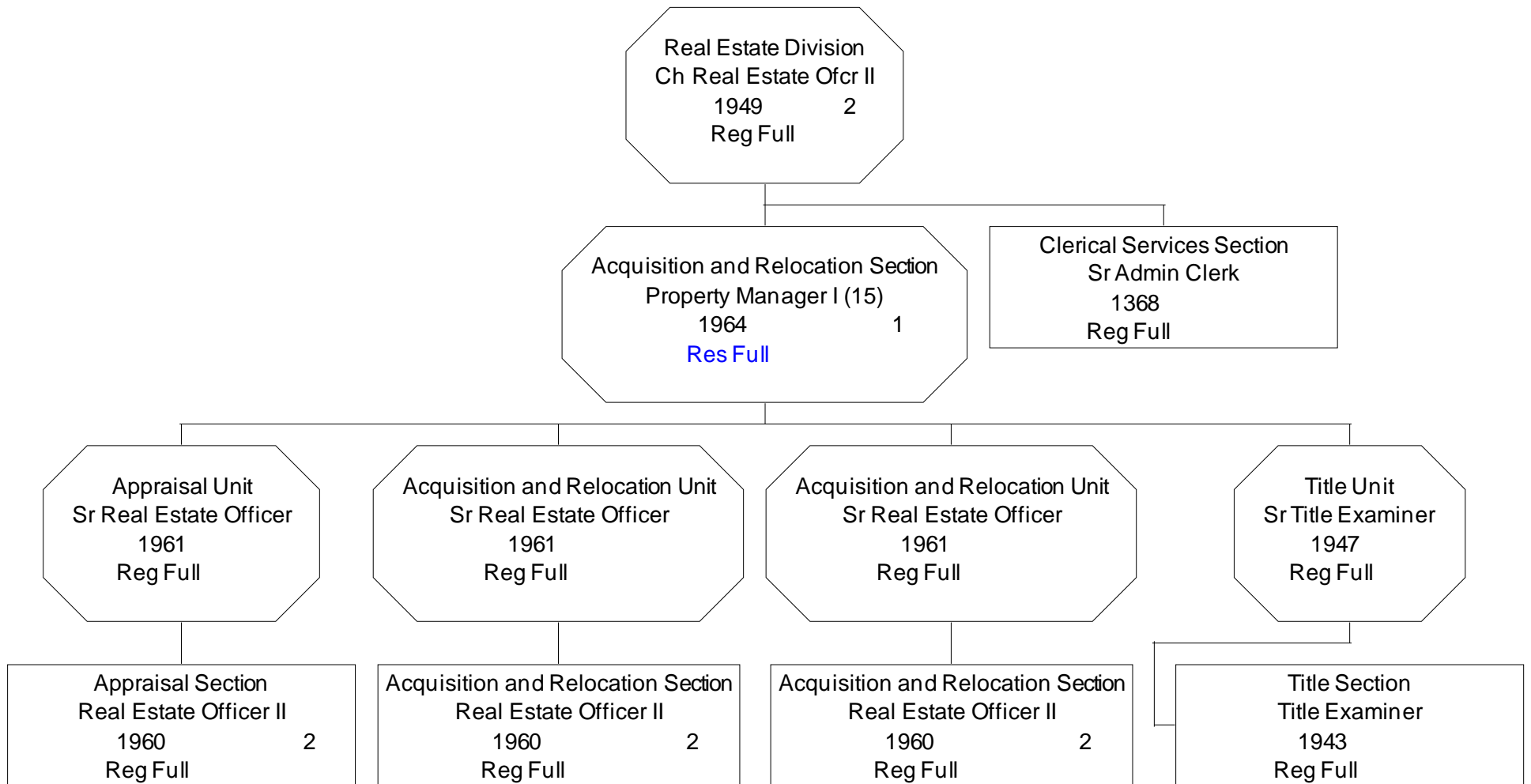

**BUREAU OF ENGINEERING
SIXTH STREET VIADUCT DIVISION
2019-20 ORGANIZATION CHART**

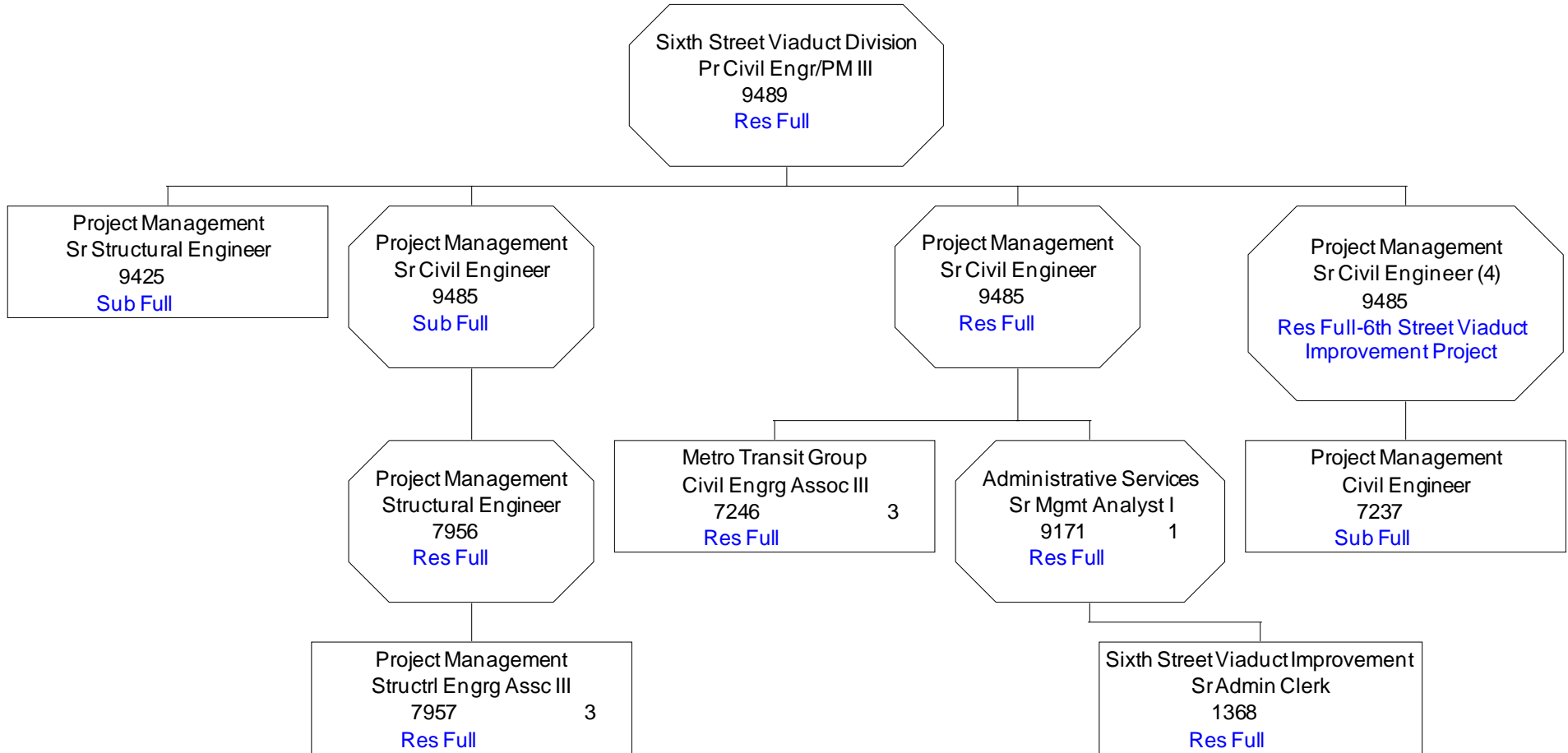

BUREAU OF ENGINEERING

STREET IMPROVEMENT AND STORMWATER DIVISION (PAGE 1 OF 2)

2019-20 ORGANIZATION CHART

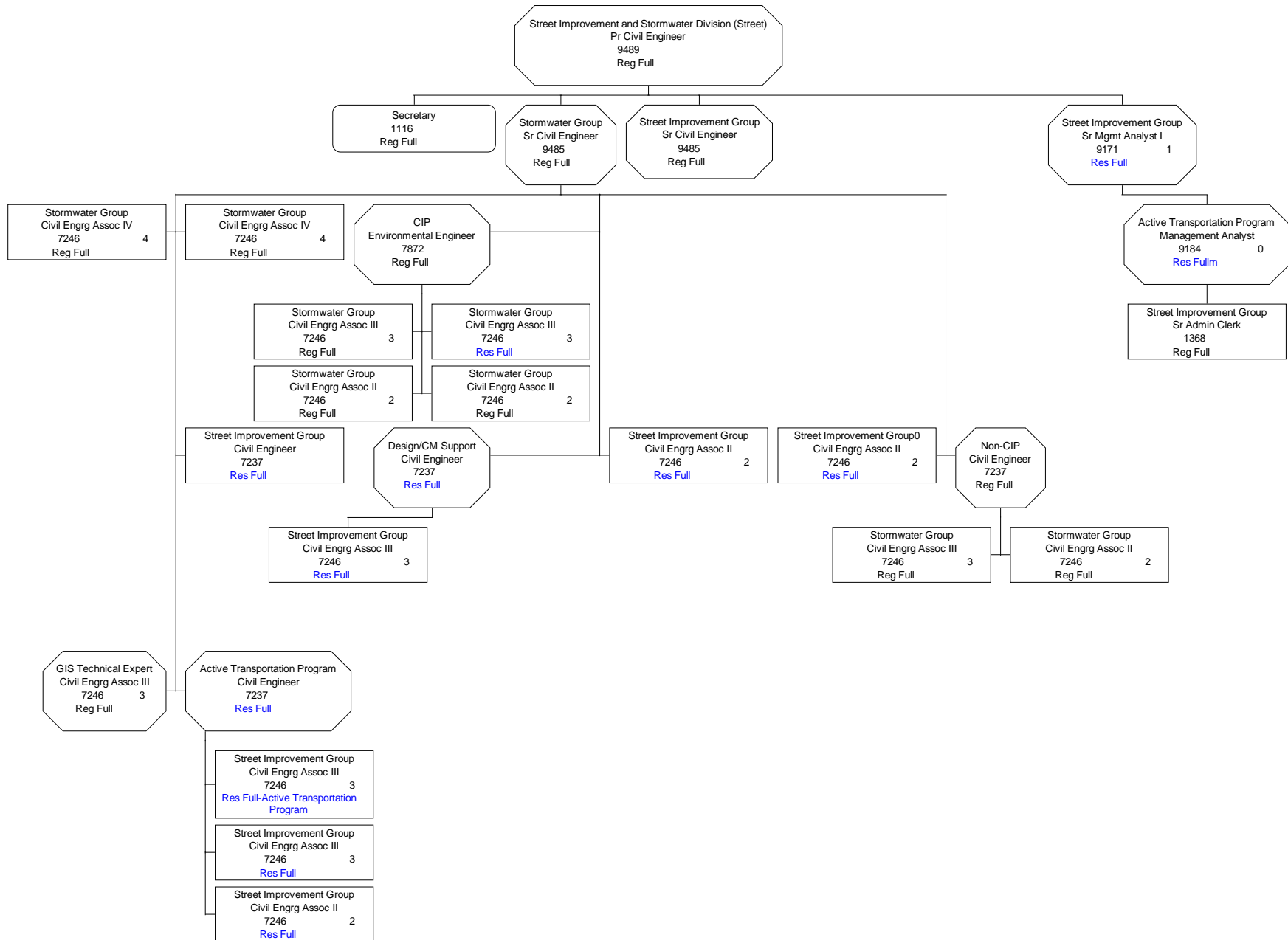

BUREAU OF ENGINEERING STREET IMPROVEMENT AND STORMWATER DIVISION (PAGE 2 OF 2) 2019-20 ORGANIZATION CHART

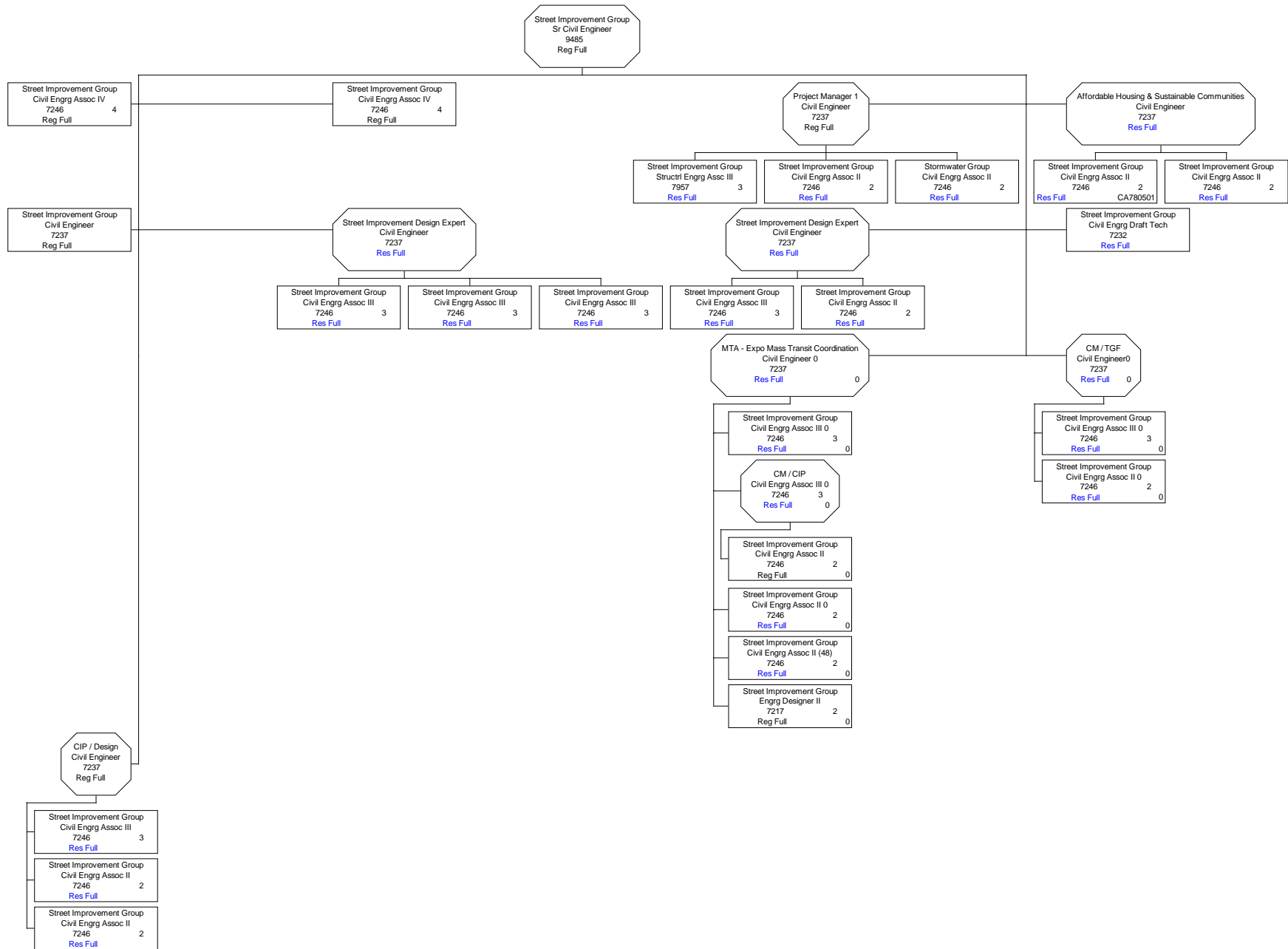

**BUREAU OF ENGINEERING
SIDEWALK AND COMPLETE STREETS PROGRAM
2019-20 ORGANIZATION CHART**

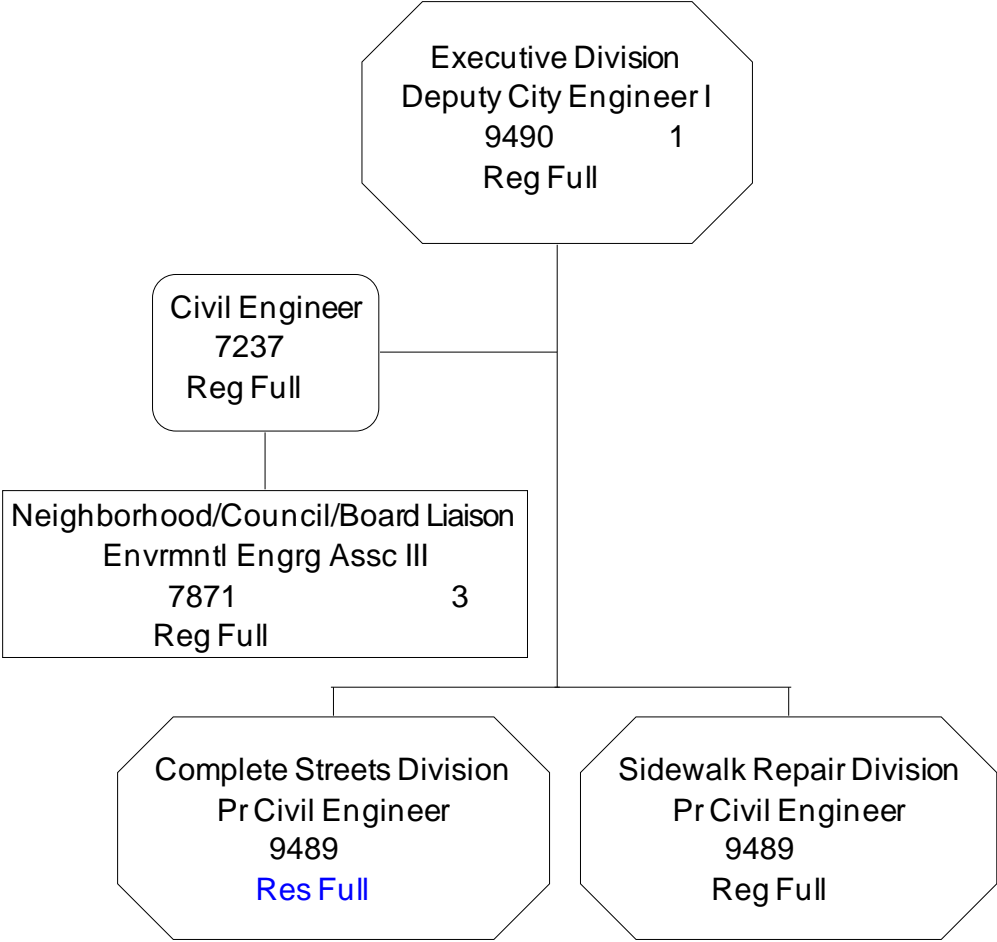

**BUREAU OF ENGINEERING
COMPLETE STREETS DIVISION
2019-20 ORGANIZATION CHART**

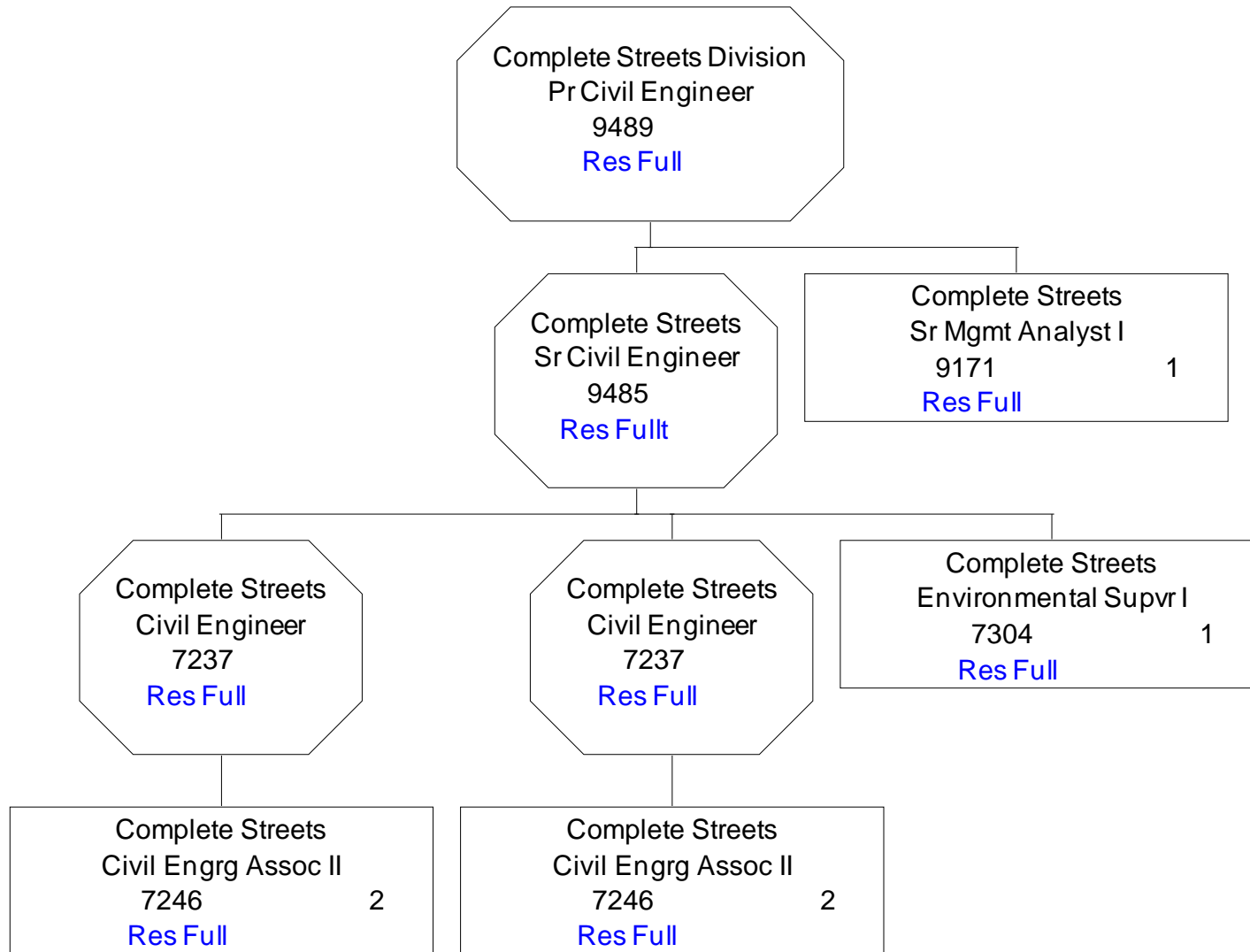

**BUREAU OF ENGINEERING
SIDEWALK REPAIR DIVISION
2019-20 ORGANIZATION CHART**

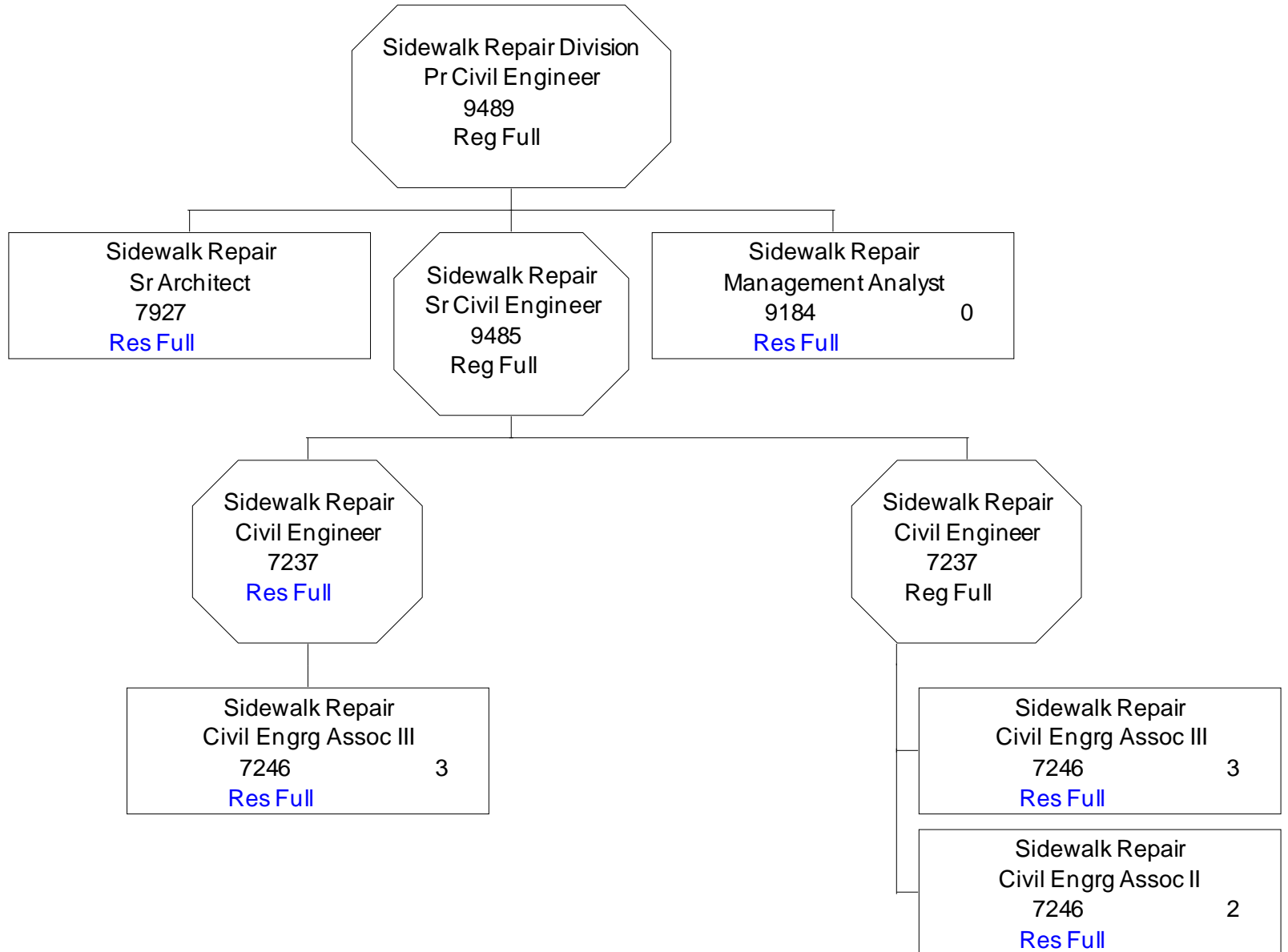

BUREAU OF ENGINEERING ADMINISTRATION DIVISION 2019-20 ORGANIZATION CHART

